

Outdoor Collection 2022

● Amanda	368
● Aurora	50
● Chelsea	82
● Experience	124
● Lipari	284
● Luce	154
● Nagi	300
● Pevero	176
● Shibuya®	330
● Solaire	340
● Solare	416
● Synthesis	198
● Swing	224
● Toscana	246
● Welcome	258

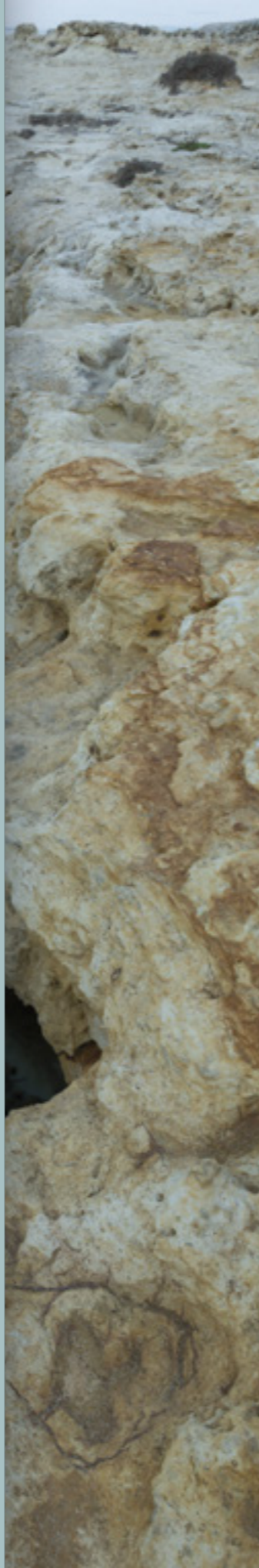



Collections

Agorà	18
Ariete	38
M Aurora	50
C'est La Vie	66
M Chelsea	82
Conrad	112
M Experience	124
Les Arcs	136
M Luce	154
Olimpia	168
M Pevero	176
M Synthesis	198
M Swing	224
Tline	232
M Toscana	246
M Welcome	258

Sunshades

Covercar	274
Dafne	280
M Lipari	284
Manta	294
M Nagi	300
Orangerie	314
Salento	322
M Shibuya [®]	330
M Solaire	340
Tibisco	356

Complements
and Lights

M Amanda	368
Art of the Table	376
Aton	382
Barby	388
Capri	392
Carpets	398
Hotty	404
Jolly Cushions	408
Solar Shower	412
M Solare	416
Urbn Balcony	424
Vases	434

Care and
Maintenance

Cleaning kit & Paint	440
Protection Covers	443
Summary	
Finishes & Materials	454
Colour Collection	456

M Masterline Collections

Amanda	368
Aurora	50
Chelsea	82
Experience	124
Lipari	284
Luce	154
Nagi	300
Pevero	176
Shibuya®	330
Synthesis	340
Solaire	416
Solare	198
Swing	224
Toscana	246
Welcome	258

The Masterline collections embody Unopiù's style and soul, blending functionality with timeless elegance. Each line includes the company's iconic pieces, where its excellent craftsmanship is enhanced through production processes aimed at meeting the demand for products all year long.

IT Le linee Masterline rappresentano lo stile e l'anima di Unopiù, combinando funzionalità ad un'eleganza senza tempo. Ciascuna collezione racchiude i pezzi iconici dell'azienda, dove l'eccellenza artigianale si consolida attraverso un processo produttivo mirato a soddisfare la domanda dei prodotti in tutti i periodi dell'anno.

FR Les lignes Masterline représentent le style et l'âme d'Unopiù, alliant fonctionnalité et élégance intemporelles. Chaque collection contient les pièces emblématiques de l'entreprise, où l'excellence du savoir-faire artisanal est affirmée par un processus de production visant à répondre à la demande de produits à tout moment de l'année.



Unopiù was founded on a desire to conceive the outdoors as an additional space that can be furnished using versatile, elegant and functional solutions, created to stand the test of time and adapting harmoniously to the environment. Nowadays, the company represents one of the most significant reference points in the outdoor world, seen as somewhere to spend time in tune with nature, which gives those who live there a feeling of comfort, well-being and freedom.

IT Unopiù nasce dalla volontà di immaginare l'esterno come lo spazio in più da arredare attraverso soluzioni versatili, eleganti e funzionali, nate per durare nel tempo adattandosi armoniosamente all'ambiente.

L'azienda rappresenta oggi uno dei punti di riferimento più significativi del mondo dell'outdoor, concepito come un luogo dove trascorrere il tempo in connessione con la natura, che restituisce a chi la abita una sensazione di comfort, benessere, libertà.

FR Unopiù invite à imaginer l'extérieur comme un espace supplémentaire à aménager à l'aide de solutions polyvalentes, élégantes et fonctionnelles, conçues pour durer dans le temps et s'intégrer harmonieusement à l'environnement.

L'entreprise représente aujourd'hui l'une des principales références en matière d'aménagement d'espaces extérieurs, qui deviennent des lieux privilégiés où l'on peut passer du temps en contact avec la nature tout en bénéficiant d'une sensation de confort, de bien-être et de liberté.

1978





A long story

in

Italian

design

Each new collection is rooted in the decades-old tradition of the company, reinterpreting it through elegant, contemporary forms. Since 1978 Unopiù always worked with the most influential Italian and International designer to create innovative outdoor solutions where functionality combines with recognisable, discreet aesthetics, capable of harmoniously integrating with the natural environment, respecting its identity.

IT Ogni nuova collezione affonda le sue radici nella tradizione decennale dell'azienda, reinterpretandola attraverso forme eleganti e contemporanee. Sin dal 1978 Unopiù ha collaborato con i designer italiani ed internazionali più influenti, per dare forma a soluzioni per l'esterno innovative, dove la funzionalità dialoga con un'estetica riconoscibile, discreta, capace di integrarsi armonicamente con l'ambiente naturale, rispettandone l'identità.

FR Chaque nouvelle collection s'enracine dans la tradition pluridécennale de l'entreprise, en la réinterprétant à travers des formes élégantes et contemporaines. Depuis 1978, Unopiù a toujours travaillé avec le designer italien et international le plus influent pour créer des solutions d'extérieur innovantes où la fonctionnalité se combine à une esthétique reconnaissable et discrète, capable de s'intégrer harmonieusement à l'environnement naturel, en respectant son identité.

The environment

Since the beginning, Unopiù has offered its customers the opportunity to furnish their outdoor environments with simplicity and versatility. The furniture in each collection respects the identity of the landscape it inhabits, be it an urban balcony, the garden of a villa or a terrace overlooking the sea. Unopiù offers tailor-made solutions capable of combining with the surrounding nature, ensuring a pleasant feeling of well-being.

IT Sin dalla nascita Unopiù offre ai propri clienti la possibilità di arredare l'ambiente esterno con semplicità e versatilità. I mobili di ciascuna collezione rispettano l'identità del paesaggio che abitano, sia esso un balcone urbano, il giardino di una villa o un terrazzo affacciato sul mare. Unopiù propone soluzioni su misura capaci di dialogare con la natura circostante, garantendo una piacevole sensazione di benessere.

FR Depuis sa création, Unopiù offre à ses clients la possibilité d'aménager les environnements extérieurs de manière simple et polyvalente. Les meubles de chaque collection respectent l'identité du cadre dans lesquels ils se trouvent, qu'il s'agisse d'un balcon urbain, d'un jardin dans une villa ou d'une terrasse face à la mer. Unopiù propose des solutions sur mesure qui s'intègrent parfaitement dans la nature environnante tout en offrant une agréable sensation de bien-être.

is the

main

purpose



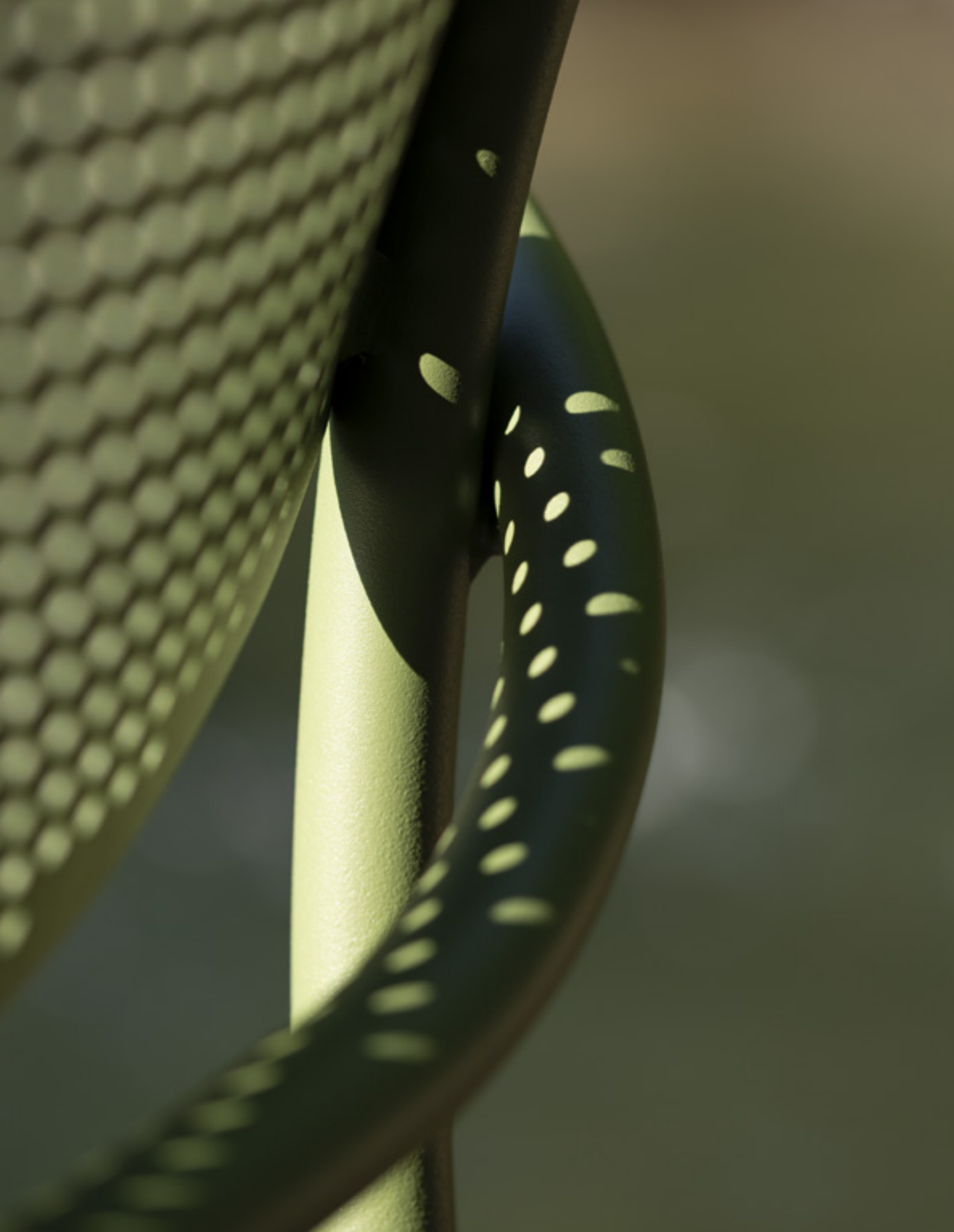

The quality

The quality of the raw materials has always been the solid basis of the company's production and innovation process. Quality and functionality translate into simple and elegant forms that are capable of lasting over time enriching the customer experience with everlasting pleasure.

We look for the most sustainable raw materials and we continue to make responsible choices that respect the nature we furnish and the future of our community.

Unopiù creates design furnitures that lasts for a lifetime: maintenance of our furniture donate them a long lasting pleasure to our customers avoiding waste and consumption.

IT La qualità della materia prima è da sempre la base solida del processo di produzione ed innovazione dell'azienda. Qualità e funzionalità si traducono in forme semplici ed eleganti capaci di durare nel tempo e arricchire di comfort l'esperienza del cliente.

Ricerchiamo le materie prime più sostenibili e continuiamo ad operare scelte responsabili nel rispetto della natura che arrediamo e del futuro della nostra comunità.

Unopiù produce arredi capaci di durare per tutta la vita: grazie alla loro manutenzione dona ai nostri clienti un benessere permanente, evitando sprechi e consumi.

of our

FR La qualité des matières premières a toujours été la base du processus de production et d'innovation de l'entreprise. La qualité et la fonctionnalité se traduisent par des formes simples et élégantes capables de durer dans le temps et d'enrichir l'expérience client d'un plaisir éternel.

Nous recherchons les matières premières les plus durables et nous continuons à faire des choix responsables qui respectent la nature que nous fournissons et l'avenir de notre communauté.

Unopiù crée des meubles de design qui durent toute une vie : l'entretien de nos meubles permet d'offrir un plaisir durable à nos clients en évitant le gaspillage et la consommation.

materials

Collections

Agorà

Ariete

Aurora

C'est La Vie

Chelsea

Conrad

Experience

Les Arcs

Luce

Olimpia

Pevero

Synthesis

Swing

Tline

Toscana

Welcome

Agorà

Agorà stands out due to its soft, organic forms. The rounded, enveloping character found in each product in the collection expresses a sense of comfort.

The aluminium frame is as light as it is sturdy and its combination with the fibre, which is resistant to any atmospheric agent, gives it a sense of timelessness.

IT Agorà si distingue per le sue forme morbide ed organiche. Il carattere tondeggiante e avvolgente ricorre in ciascun prodotto della collezione esprimendo un senso di comfort.

La struttura in alluminio è tanto leggera quanto robusta e la combinazione con la fibra, resistente a tutti gli agenti atmosferici, le conferisce un sapore senza tempo.

FR Agorà se distingue par ses formes souples et naturelles. La rondeur et la douceur se retrouvent dans tous les éléments de la collection et lui confèrent un style douillet et confortable.

La structure en aluminium, aussi légère que robuste, se combine à la fibre, qui résiste à tous les agents atmosphériques, et confère un style intemporel.

The upholstery, made of synthetic fibre, skilfully hand-woven into a dense, robust lattice, enhances the shapes and makes them welcoming.

IT Il rivestimento, in fibra sintetica sapientemente intrecciata a mano in un reticolo fitto e resistente, esalta i volumi rendendola accogliente.

FR Le revêtement en fibre synthétique, dense, résistante et soigneusement tissée à la main dense et résistant, met en valeur les volumes et apporte une touche chaleureuse.







The back of the corner module creates a whole with the armrest, making the seat ample and comfortable.

IT Lo schienale del modulo angolare crea un tutt'uno con il bracciolo rendendo la seduta ampia e comoda.

FR Le dossier du module angulaire forme un tout avec l'accoudoir, offrant ainsi une assise large et confortable.





Agorà consists of versatile, modular furnishings that allow the creation of linear and L-shaped configurations and linear sofas, customising outdoor spaces according to any need.

IT Agorà si compone di arredi versatili e modulari che permettono di creare configurazioni lineari ed a L, personalizzando gli spazi esterni in base a ogni esigenza.

FR Agorà se compose de meubles polyvalents et modulaires qui permettent de créer des configurations linéaires et de personnaliser les espaces extérieurs en fonction des diverses exigences.

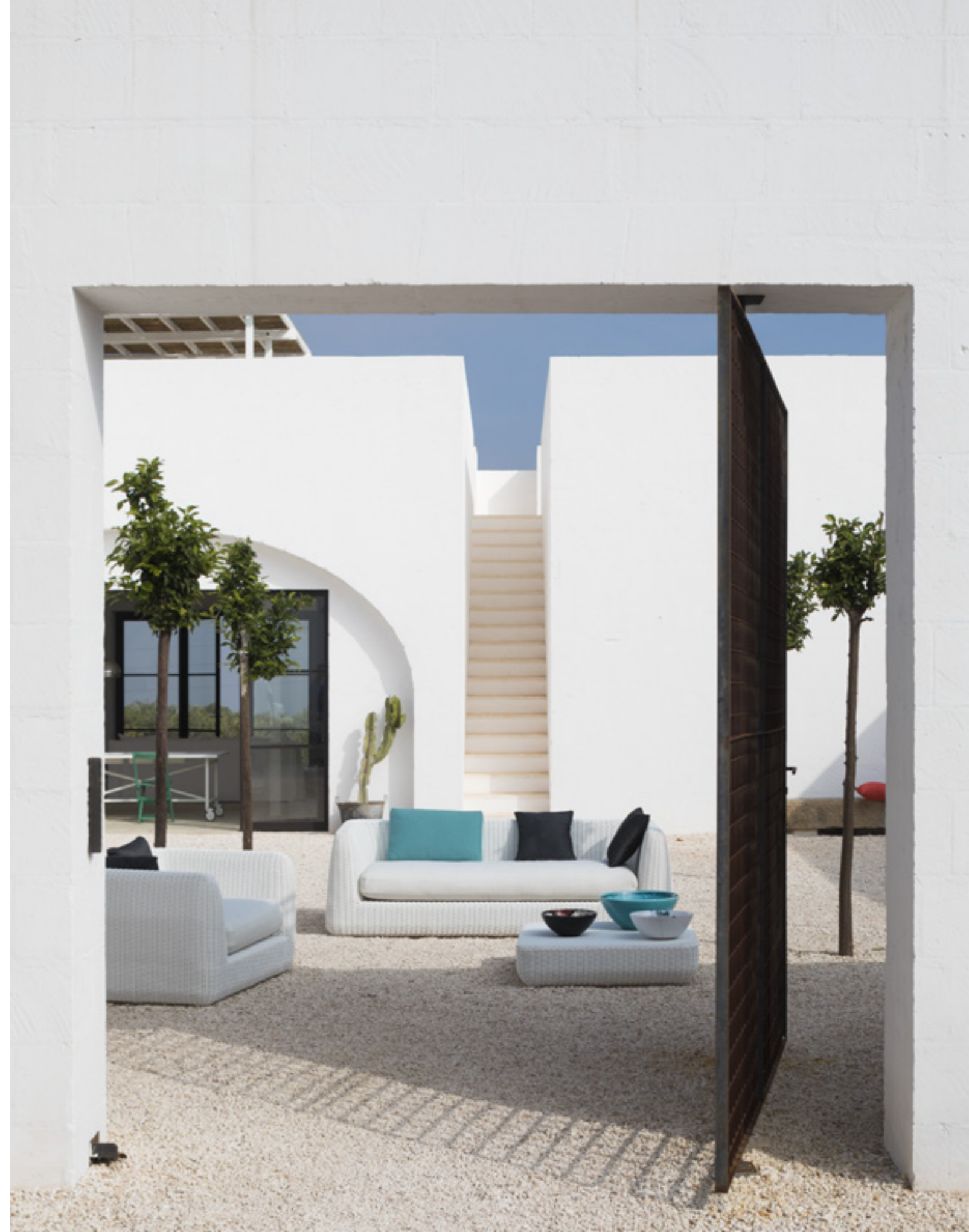



Enveloping proportions and solid shapes result in a range with traditional, recognisable and refined aesthetics, suited to relaxing moments, in harmony with the landscape.

IT Proporzioni avvolgenti e volumi solidi compongono una linea dall'estetica tradizionale, riconoscibile e raffinata, adatta per momenti di relax in armonia con il paesaggio.

FR Des proportions enveloppantes et des volumes solides caractérisent cette ligne à l'esthétique traditionnelle, typique et raffinée, propice à des moments de détente en harmonie avec le cadre environnant.









The collection is features pleasant-to-the-touch material interweaving, applied with versatility to the various accessories. The cushions echo the sinuous shapes of the sofa. The fully removable covers are not integrated into the structure to allow proper maintenance.

IT La collezione è contraddistinta dall'intreccio materico piacevole al tatto, applicato con versatilità ai diversi complementi. I cuscini seguono le forme sinuose del divano. Completamente sfoderabili non sono integrati alla struttura, per garantirne la corretta manutenzione.

FR Cette collection se caractérise par le tressage naturel agréable au toucher, qui se retrouve sur les divers éléments complémentaires. Les coussins épousent les formes sinueuses du divan. Totalement déhoussables, ils ne sont pas intégrés à la structure, de manière à faciliter leur entretien.



- Synthetic fibre / Fibra sintetica / Fibre synthétique
- Removable cushions col. standard Diamante 001 / Cuscini sfoderabili col. standard Diamante 001 / Coussins déhoussables col. standard Diamante 001

Sitting and lounge / Seduta e lounge / Assise et lounge

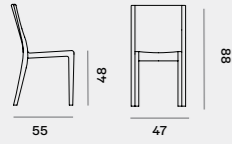

Chair / Sedia / Chaise

SEAGB

White / Bianco / Blanc

SEAGTBR

Tropical brown / Tropical brown / Tropical brown



Armchair / Poltrona / Fauteuil

AGPOB

White / Bianco / Blanc

AGPOT

Tropical brown / Tropical brown / Tropical brown

AGCUPO

Cushion / Cuscino / Coussin

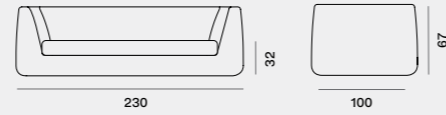

Sofa / Divano / Canapé

AGDIB

White / Bianco / Blanc

AGDIT

Tropical brown / Tropical brown / Tropical brown

AGCUDI

Cushion / Cuscino / Coussin

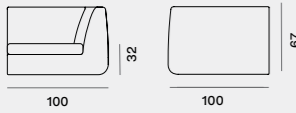

Lt module / Modulo sx / Module g

AGANB

White / Bianco / Blanc

AGANT

Tropical brown / Tropical brown / Tropical brown

AGCUAN

Cushion / Cuscino / Coussin

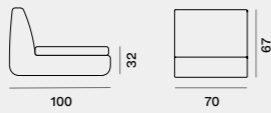

Backrest module / Modulo spalla / Module dossier

AGSPB

White / Bianco / Blanc

AGSPT

Tropical brown / Tropical brown / Tropical brown

AGCUSP

Cushion / Cuscino / Coussin



Rt end module / Modulo finale dx / Module terminal d

AGMFBP

White / Bianco / Blanc

AGMFTD

Tropical brown / Tropical brown / Tropical brown

AGCUMF

Cushion / Cuscino / Coussin



Lt End module / Modulo finale sx / Module terminal g

AGMFBS

White / Bianco / Blanc

AGMFTS

Tropical brown / Tropical brown / Tropical brown

AGCUMF

Cushion / Cuscino / Coussin



Rt Lounge module / Modulo lounge dx / Module lounge d

AGMLBD

White / Bianco / Blanc

AGMLTD

Tropical brown / Tropical brown / Tropical brown

AGCUMLD

Cushion / Cuscino / Coussin



Lt lounge module / Modulo lounge sx / Module lounge g

AGMLBS

White / Bianco / Blanc

AGMLTS

Tropical brown / Tropical brown / Tropical brown

AGCUMLS

Cushion / Cuscino / Coussin

- Synthetic fibre / Fibra sintetica / Fibre synthétique
- Removable cushions col. standard Diamante 001 / Cuscini sfoderabili col. standard Diamante 001 / Coussins déhoussables col. standard Diamante 001

Sunloungers / Lettini / Bains de soleil



Sunlounger / Lettino / Bain de soleil

AGLEB

White / Bianco / Blanc

AGLET

Tropical brown / Tropical brown / Tropical brown

AECU

Cushion / Cuscino / Coussin



Island / Struttura isola / Îlot

EDISTB

White / Bianco / Blanc

EDIST

Tropical brown / Tropical brown / Tropical brown

EDCUIS

Cushion / Cuscino / Coussin

Tables / Tavoli / Table

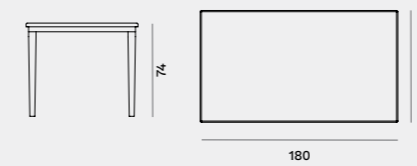

Rectangular table / Tavolo rettangolare / Table rectangulaire

TAGRB

White / Bianco / Blanc

TAGRTBR

Tropical brown / Tropical brown / Tropical brown

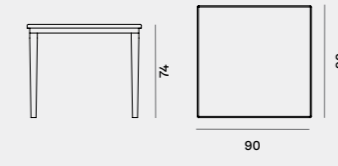

Square table / Tavolo quadrato / Table carré

TAGQB

White / Bianco / Blanc

TAGQTBR

Tropical brown / Tropical brown / Tropical brown

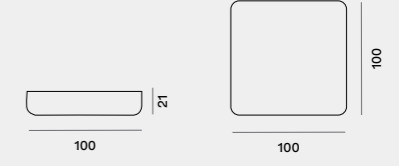

Square coffee table / Tavolino quadrato / Table basse carré

BAGTAB

White / Bianco / Blanc

AGTAB

Tropical brown / Tropical brown / Tropical brown

AGCUPU

Cushion pouf / Cuscino pouf / Coussin pouf



Round coffee table / Tavolino rotondo / Table basse ronde

EDPTTB

White / Bianco / Blanc

EDPTT

Tropical brown / Tropical brown / Tropical brown

VETAED50

Glass top / Copertura vetro / Verre pour table

EDCUPU

Cushion pouf / Cuscino pouf / Coussin pouf

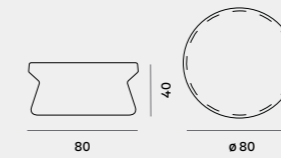

Glass top Coffee table / Tavolino con top in vetro / Table basse avec plateau en verre

TAED80B

White / Bianco / Blanc

TAED80

Tropical brown / Tropical brown / Tropical brown

Finishes / Finiture / Finitions

 Synthetic fibre tropical brown
Fibra sintetica tropical brown
Fibre synthétique tropical brown

 Synthetic fibre white
Fibra sintetica bianca
Fibre synthétique blanche

 Removable cushions Masterline Colour Collection pg. 458
Cuscini sfoderabili Masterline Colour Collection pg. 458
Coussins déhoussables Masterline Colour Collection pg. 458

Ariete

Designed by Adam D. Tihany, Ariete enhances the primary geometry of the circle as a unique feature through which to reinterpret wrought iron work in a contemporary style.

The generously sized collection is handcrafted by skilled craftsmen and includes sofas, armchairs, tables and seating that are ideal for decorating environments with timeless elegance.

IT Disegnata da Adam D. Tihany, Ariete valorizza la geometria primaria del cerchio come tratto peculiare per reinterpretare in chiave contemporanea le lavorazioni in ferro battuto.

La collezione dalle proporzioni generose è realizzata a mano da sapienti artigiani, ed include divani, poltrone, tavoli e sedute ideali per arredare gli ambienti con eleganza senza tempo.

FR Conçue par Adam D. Tihany, Ariete valorise la géométrie primaire du cercle et en fait un trait distinctif, tout en modernisant les éléments en fer forgé.

Les produits de cette collection aux proportions généreuses sont réalisés à la main par des maîtres artisans et comprennent des canapés, un fauteuil, des tables et des sièges, parfaits pour meubler les environnements extérieurs en leur conférant un style élégant et intemporel.







The generous sizes are reflected by the upholstered items that complete the sofas, available in the various nuances of the Unopiù Colour Collection.

IT I volumi generosi vengono ripresi negli imbottiti che completano i divani disponibili nelle diverse nuance della Colour Collection Unopiù.

FR Les volumes généreux se retrouvent dans les éléments rembourrés qui complètent les canapés, disponibles dans différentes nuances de la Colour Collection Unopiù.









The typical curl pattern is enlarged and closed within a circular decoration, giving it not only a decorative, but also a structural purpose. Furthermore, it softens the furnishings in the line with grace, functionality and freshness.

IT Il tipico motivo a ricciolo viene ampliato e chiuso in un decoro a cerchio, attribuendogli non solo una funzione decorativa, ma anche uno scopo strutturale, inoltre ingentilisce con grazia, funzionalità e freschezza gli arredi della linea.

FR Le motif typique des boucles est amplifié et crée un ensemble formé de cercles qui revêt une fonction non seulement décorative, mais également structurelle, apportant ainsi un aspect raffiné, fonctionnel et plein de fraîcheur aux meubles de cette ligne.



Ariete

- Powder coated galvanized iron / Ferro zincato verniciato a polveri / Fer galvanisé enduit de poudre
- Removable cushions col. standard Diamante 001 / Cuscini sfoderabili col. standard Diamante 001 / Coussins déhoussables col. standard Diamante 001

Sitting / Sedute / Assises

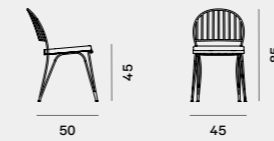

Chair / Sedia / Chaise
ARISED

CUARISED
Cushion / Cuscino / Coussin

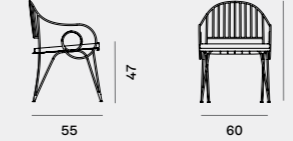

Small armchair / Poltroncina / Petit fauteuil
ARIPOBR

CUARIP
Cushion / Cuscino / Coussin

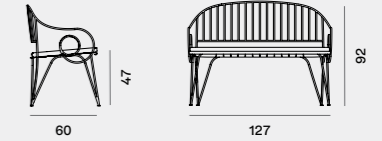

Bench / Panchetta / Banc
ARIPANBR

CUARIPAN
Cushion / Cuscino / Coussin

Lounge / Lounge / Lounge

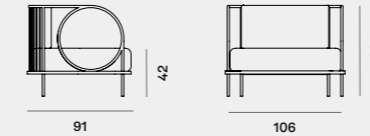

Armchair / Poltrona / Fauteuil
ARIPOLGBR

CUARIPOL
Cushion / Cuscino / Coussin

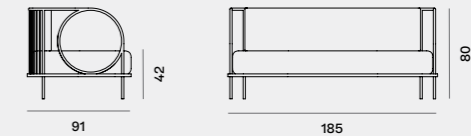

Sofa / Divano / Canapé
ARIDIVGBR

CUARIDIV
Cushion / Cuscino / Coussin

Tables / Tavoli / Tables

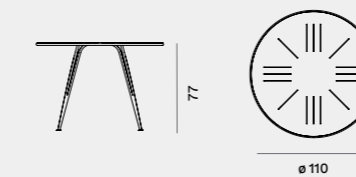

Round table / Tavolo rotondo / Table ronde
ARITAVROBR

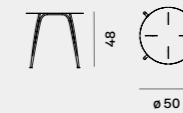

Round coffee table / Tavolino rotondo / Table basse ronde
ARITBROT

Finishes / Finiture / Finitions

● Powder coated galvanized iron bronze
Ferro zincato verniciato a polveri bronzo
Fer galvanisé enduit de poudre bronze

● Removable cushions Masterline Colour Collection pg. 458
Cuscini sfoderabili Masterline Colour Collection pg. 458
Coussins déhoussables Masterline Colour Collection pg. 458

Hand forged and inspired by the Umbrian-Tuscan tradition of the late 1900s, Aurora is a classic, traditional collection that, thanks to its forms, manages to create a romantic, refined atmosphere. What makes it stand out is the powder-coated wrought iron frame, which encapsulates its perfect combination of elegance and durability.

IT Forgiata a mano e ispirata dalla tradizione umbro-toscana di fine '900, Aurora si presenta come una collezione classica e tradizionale capace grazie alle sue forme, di creare un'atmosfera romantica e raffinata. Ciò che la distingue è la struttura in ferro battuto verniciata a polveri, che riassume il perfetto connubio tra eleganza e durevolezza.

FR Composée de fer forgé à la main et s'inspirant du style traditionnel de l'Ombrie et de la Toscane de la fin du 19e siècle, Aurora est une collection classique et traditionnelle dont les formes permettent de créer une ambiance romantique et raffinée. Elle se distingue par ses structures en fer forgé revêtu de poudre noire, qui offre une union parfaite entre l'élégance et la robustesse.

The subtle decoration is synonymous with craftsmanship.

IT Il decoro sottile è sinonimo di artigianalità.

FR La fabrication artisanale offre une décoration subtile.







The succession of soft, round forms is also mirrored in the upholstered furniture, which appears welcoming and comfortable. The cushions are removable and not integrated into the structure, to ensure proper care and maintenance.

IT La successione di forme morbide e rotonde viene ripresa anche negli imbottiti che appaiono accoglienti e confortevoli. I cuscini sono sfoderabili e non integrati alla struttura, per garantirne la corretta cura e manutenzione.

FR La succession de formes souples et rondes se retrouve dans les parties matelassées à l'aspect douillet et confortable. Les coussins sont déhoussables et indépendants de la structure afin de faciliter leur entretien.







Timeless beauty and romantic lines, the Aurora collection is rich and complete; it offers all the elements necessary to furnish the outdoors in a timeless style.

IT Bellezza senza tempo e linee romantiche, la collezione Aurora è ricca e completa; propone tutti gli elementi per arredare l'esterno con uno stile intramontabile.

FR La collection Aurora, riche et complète, se caractérise par sa beauté intemporelle et ses lignes romantiques. Elle propose tous les éléments nécessaires pour aménager vos espaces extérieurs et offre un style intemporel.







From the sofa to the armchair, from the chairs to the tables and from the lounge to the cabinet, a hot-dip galvanising treatment makes the products highly durable and provides protection against atmospheric agents.

IT Dal divano alla poltrona, dalle sedie ai tavoli e dal lettino all'armadietto, il trattamento con zincatura conferisce ai prodotti un'elevata resistenza e protezione contro gli agenti atmosferici.

FR Du canapé au fauteuil, des chaises aux tables basses et du transat à l'armoire, le traitement par galvanisation confère à ces produits une très grande résistance aux agents atmosphériques.



- Powder coated galvanized iron / Ferro zincato verniciato a polveri / Fer galvanisé enduit de poudre
- Removable cushions col standard Latte 04 / Cuscini sfoderabili col standard Latte 04 / Coussins déhoussables col standard Latte 04
- Technical fabric / Tessuto tecnico / Tissu technique

Sitting / Sedute / Assises

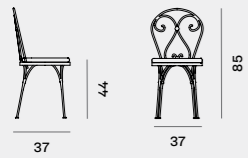

Chair / Sedia / Chaise
AUSN

CUABA
Cushion / Cuscino / Coussin

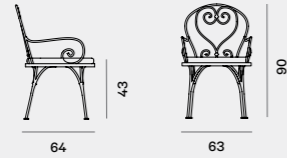

Small armchair / Poltroncina / Petit fauteuil
AUPOLG

CUPAUBA-S2
Cushion / Cuscino / Coussin

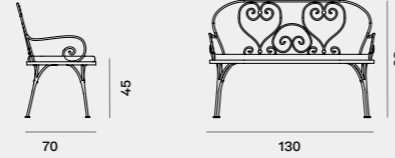

Bench / Panchetta / Banc
AUDIG

CUDAUBA-S2
Cushion / Cuscino / Coussin

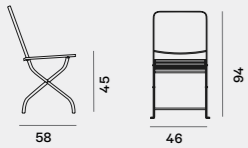

Chair / Sedia / Chaise
CESEG

CUCEPSA
Cushion / Cuscino / Coussin

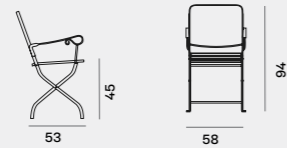

Small Chair / Sedia piccola / Petit fauteuil
CEPOG

CUCEPSA
Cushion / Cuscino / Coussin

Lounge / Lounge / Lounge

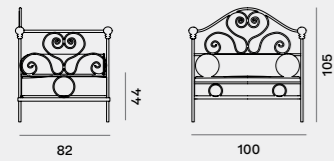

Armchair / Poltrona / Fauteuil
MORPOS

CUSMOPOA
Cushion / Cuscino / Coussin

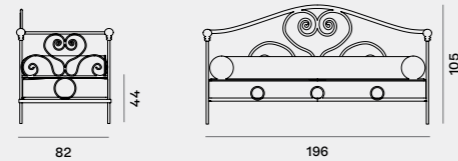

Sofa / Divano / Canapé
MORDIS

CUSMORA
Cushion / Cuscino / Coussin

Sunlounger / Lettino / Bain de soleil

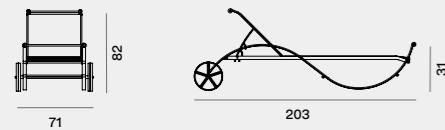

Sunlounger / Lettino / Bain de soleil
LELEGTM

- Powder coated galvanized iron / Ferro zincato verniciato a polveri / Fer galvanisé enduit de poudre
- Removable cushions col standard Latte 04 / Cuscini sfoderabili col standard Latte 04 / Coussins déhoussables col standard Latte 04
- Technical fabric / Tessuto tecnico / Tissu technique

Tables / Tavoli / Tables

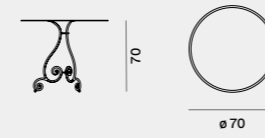

Round table / Tavolo rotondo / Table ronde
TALFG

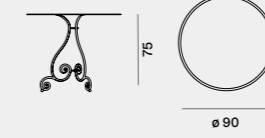

Round table / Tavolo rotondo / Table ronde
TALFG9

Accessories / Accessori / Accessoires

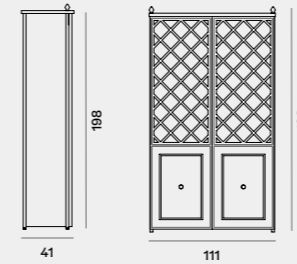

Cupboard / Armadio / Armoire
LARM

Finishes / Finiture / Finitions

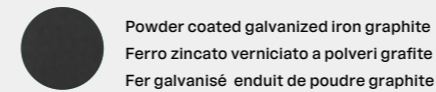

Powder coated galvanized iron graphite
Ferro zincato verniciato a polveri grafite
Fer galvanisé enduit de poudre graphite

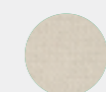

Removable cushions Masterline Colour Collection pg. 458
Cuscini sfoderabili Masterline Colour Collection pg. 458
Coussins déhoussables Masterline Colour Collection pg. 458

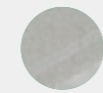

Polycarbonate panels (LARM)
Pannelli policarbonato (LARM)
Polycarbonate panneaux (LARM)

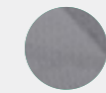

Technical fabric brown
Tessuto tecnico brown
Tissu technique brown

C'est La Vie

Designed by Michele Bönan, the C'est La Vie collection stands out due to its construction in precious polished sapelli mahogany, a material that lends elegance, solidity and harmony to each element.

Polishing enhances its lines, making the material pleasant to the touch and generating an alluring complicity between the piece of furniture and the reflections of the natural environment.

IT Disegnata da Michele Bönan, C'est La Vie è una collezione che si distingue per la sua realizzazione in pregiato legno di mogano Sapelli lucidato, materiale che conferisce eleganza, solidità ed armoniosità a ciascun elemento che la compone. La lucidatura esalta le sue linee, rendendo il materiale piacevole al tatto e generando un affascinante dialogo tra il mobile e i riflessi dell'ambiente naturale.

FR Conçue par Michele Bönan, C'est La Vie est une collection qui se distingue par l'utilisation de bois précieux d'acajou Sapelli poli, un matériau qui confère un style élégant et harmonieux ainsi qu'une grande robustesse à tous les éléments qui la composent.

Les lignes sont mises en valeur par la brillance du bois, un matériau agréable au toucher qui permet de créer un dialogue fascinant entre le mobilier et les reflets de l'environnement naturel.

The natural veins draw delicate motifs that complement the geometric lines of the collection, giving the furnishings a timeless class.

IT Le venature naturali disegnano motivi delicati che completano le linee geometriche della collezione, donando agli arredi una classe senza tempo.

FR Les veinures naturelles dessinent des motifs délicats qui viennent enrichir les lignes géométriques de cette collection et qui lui confère un style luxueux intemporel.







Formal details are used on all the modules in the series, with which it is possible to create linear sofas and L-shaped compositions, customising the space available to the fullest.

IT I dettagli formali ricorrono in tutti i moduli della serie, con cui è possibile creare divani lineari, composizioni a L, personalizzando al meglio lo spazio disponibile.

FR Les détails formels se retrouvent sur tous les modules de la série, qui permettent de créer des canapés linéaires et des compositions en "L" et de personnaliser au mieux l'espace disponible.



The formal details are completed with upholstered items, embellished with top-stitching and contrasting stitching.

IT I cuscini impreziositi da impunture e cuciture a contrasto completano ciascun elemento, garantendo il massimo comfort.

FR Les détails formels s'accompagnent d'éléments matelassés, ornés de surpi-
qûres et de coutures contrastantes.







The collection stands out due to its careful attention to every little detail: from the removable table tops and loungers with adjustable backrests, to the polished stainless-steel legs that decorate and enrich each element.

IT La collezione si distingue per la cura attenta a ciascun minimo dettaglio: dai piani estraibili del tavolo e lettini con lo schienale regolabile, sino ai piedini in acciaio inossidabile lucido che decorano e arricchiscono ogni elemento.

FR Cette collection se caractérise par le soin minutieux apporté au moindre détail, des plateaux de table coulissants aux transats au dossier réglable et aux pieds en acier inoxydable brillant, qui décorent et mettent en valeur chaque élément.





Every detail embellishes the furnishings with sophistication without sacrificing functionality, making it the ideal choice for nautical environments, swimming pools and spas.

IT Tutti i particolari impreziosiscono gli arredi con raffinatezza senza rinunciare alla funzionalità, rendendola la scelta ideale per ambienti nautici, piscine e spa.

FR Tous ces détails permettent d'apporter une touche raffinée sans renoncer à la fonctionnalité, ce qui rend cette collection parfaitement adaptée aux environnements nautiques, aux piscines et aux spas.



- Polished mahogany / Mogano lucido / Acajou poli
- Removable cushions col. standard Diamante 001 / Cuscini sfoderabili col. standard Diamante 001 / Coussins déhoussables col. standard Diamante 001

Lounge / Lounge / Lounge

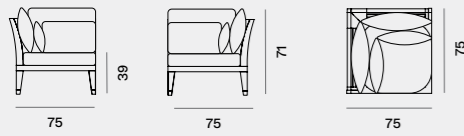

Corner Module / Modulo angolare / Module angulaire

BOMOAN

Structure / Struttura / Structure

CUBOMOAN

Cushion / Cuscino / Coussin

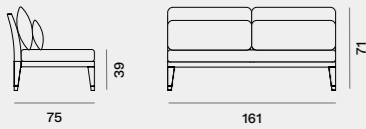

Sofa 2 seats / Divano 2 posti / Canapé 2 places

BOMODI2P

Structure / Struttura / Structure

CUBOMOSP

Cushion / Cuscino / Coussin

Sunloungers / Lettini / Bains de soleil

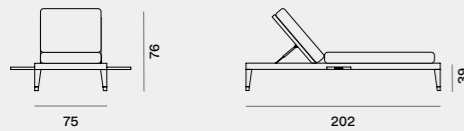

Sunlounger / Lettino / Bain de soleil

BOMOLES

Structure / Struttura / Structure

CUBOMOLES

Cushion / Cuscino / Coussin

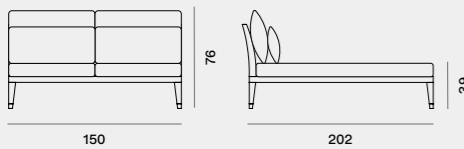

Loungebed / Letto lounge / Grand bain de soleil

BOMOLELO

Structure / Struttura / Structure

CUBOMOLELO

Cushion / Cuscino / Coussin

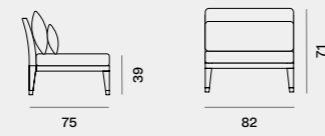

Backrest module / Modulo spalla / Module dossier

BOMOSP

Structure / Struttura / Structure

CUBOMOSP

Cushion / Cuscino / Coussin

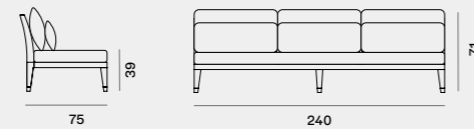

Sofa 3 seats / Divano 3 posti / Canapé 3 places

BOMODI3P

Structure / Struttura / Structure

CUBOMOSP

Cushion / Cuscino / Coussin

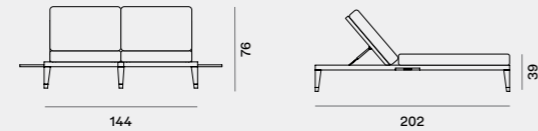

Double sunlounger / Lettino doppio / Bain de soleil double

BOMOLED

Structure / Struttura / Structure

CUBOMOLES

Cushion / Cuscino / Coussin

- Polished mahogany / Mogano lucido / Acajou poli
- Removable cushions col. standard Diamante 001 / Cuscini sfoderabili col. standard Diamante 001 / Coussins déhoussables col. standard Diamante 001

Tables / Tavoli / Tables

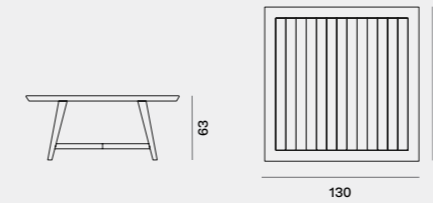

Square table / Tavolo quadrato / Table carré
BOMOTAVQ

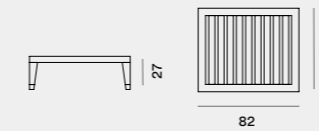

Rectangular coffee table / Tavolino / Table basse rectangulaire
BOMOTB

CUBOMOTB

Cushion pouf / Cuscino pouf / Coussin pouf



Rectangular table extractable table tops / Tavolo Rettangolare piani estraibili / Table rectangulaire avec étagères amovibles
BOMOTF

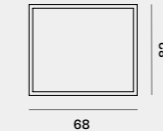

Tray / Vassoio / Plateau
BOMOVA

Finishes / Finiture / Finitions

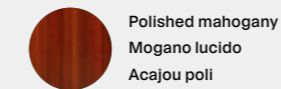

Polished mahogany
Mogano lucido
Acajou poli



Removable cushions Masterline Colour Collection pg. 458
Cuscini sfoderabili Masterline Colour Collection pg. 458
Coussins déhoussables Masterline Colour Collection pg. 458

The Chelsea line is classic and traditional, entirely made of honey-coloured teak, a shade that enhances the naturalness and warmth of the material. This highly articulated collection includes sofas, tables, chairs, loungers and deck chairs, allowing the outdoor space to be transformed into a welcoming, familiar landscape.

IT Chelsea è una linea dal gusto classico e tradizionale, interamente realizzata in teak color miele, tonalità che valorizza la naturalezza ed il calore del materiale. La collezione molto articolata include divani, tavoli, sedute, lettini e sdraio, per permettere di trasformare lo spazio esterno in un paesaggio accogliente e familiare.

FR Chelsea est une ligne au style classique et traditionnel entièrement réalisée en teck de couleur miel, une tonalité qui met en valeur l'aspect naturel et chaleureux de ce matériau. Cette collection très structurée inclut des canapés, des tables, des sièges, des transats et des chaises longues et permet de transformer son espace extérieur en un cadre accueillant et intime.







The sofa and armchair stand out due to their solid shapes and harmonious forms, which enhance the technical and aesthetic characteristics of the teak. The coffee table is characterised by a pattern of elegant horizontal slats, which lighten the compact, basic structure.

IT Il divano e la poltrona si distinguono per le forme dolci ed armoniche che esaltano le caratteristiche tecniche ed estetiche del teak. Il tavolino è caratterizzato da una trama di eleganti doghe orizzontali, che alleggeriscono la struttura compatta ed essenziale.

FR Le canapé et le fauteuil présentent des volumes solides et des formes harmonieuses qui exaltent les caractéristiques techniques et esthétiques du teck. La table basse se caractérise par élégante trame formée de lattes horizontales qui allègent la structure compacte et épurée.





The table with horizontal slats is extendable, to allow different sized spaces to be furnished.

IT Il tavolo dalle doghe orizzontali è allungabile, per permettere di arredare spazi di diverse dimensioni.

FR La table aux lattes horizontales est extensible et permet d'aménager des espaces de différentes dimensions.







The folding armchair, inspired by the famous Tripolina, is characterised by the careful finish of the leather upholstery, which makes it ideal for indoor environments, as well.

IT La poltroncina pieghevole, ispirata alla celebre Tripolina, si contraddistingue per l'attenta lavorazione del rivestimento in pelle, che la rende ideale anche per ambienti indoor.

FR Le fauteuil pliant, inspiré du célèbre fauteuil Tripolina, se distingue par la finition soignée de son revêtement en cuir, qui en fait un meuble idéal également pour les espaces intérieurs.





The seat and backrest of the folding chair are characterised by the traditional pattern of vertical and horizontal slats. A unique product that enhances the natural elegance of teak.

IT Seduta e schienale della sedia pieghevole sono caratterizzate dalla tradizionale trama a doghe verticali ed orizzontali. Un prodotto unico, che esalta l'eleganza naturale del teak.

FR L'assise et le dossier de la chaise pliante présentent une trame traditionnelle à lattes verticales et horizontales. Un produit unique qui exalte l'élégance naturelle du teck.

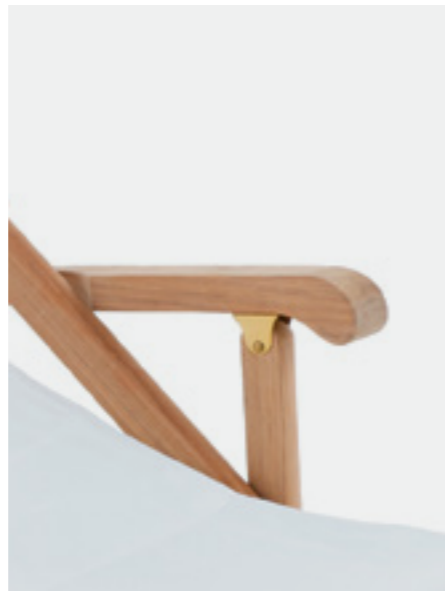



The lounge chair with its reclining backrest and folding footboard is equipped with wheels that make it easy to move, so that nature can be enjoyed from any angle in total relaxation.

IT Il lettino dallo schienale reclinabile e pediera pieghevole, è dotato di ruote che ne facilitano lo spostamento, consentendo di rilassarsi e godersi la natura da qualsiasi angolazione.

FR Le transat au dossier inclinable et au repose-pieds pliable est doté de roues qui facilitent les déplacements, permettant ainsi de se relaxer et de profiter de la nature.







The sheet, which covers the frame of the teak armchair, is available in different fabrics. The beige-coloured Canatex, particularly resistant to salt and chlorinated water, in quilted plastic fabric and classic off-white cotton.

IT Il telo, che fa da rivestimento alla struttura della poltroncina in teak, è disponibile in diversi tessuti. In Canatex di colore beige, particolarmente resistente all'acqua salata e clorata, in tessuto plastico trapuntato e in classico cotone bianco.

FR Le tissu, qui recouvre la structure du fauteuil en teck, est disponible en différents tissus. En Canatex de couleur beige, particulièrement résistant au sel et à l'eau chlorée, en tissu plastique matelassé et coton blanc cassé classique.





The Chaise longue has a removable footrest. The reclining backrest, enriched by a soft cushion, offers a special kind of comfort. Its traditional lines lend it an air of timelessness.

IT La Chaise longue è composta dal poggiatesta amovibile. Lo schienale reclinabile arricchito dal soffice cuscino offre un comfort speciale. Le sue linee tradizionali la rendono un pezzo dal sapore senza tempo.

FR La chaise longue est composée d'un repose-pied amovible. Le dossier inclinable orné d'un coussin moelleux offre un confort inimitable. Ses lignes classiques en font un meuble au style intemporel.



The trunk that completes the line is characterised by an adjustable internal shelf and dual opening: from above and from the front. Made of solid teak with stainless steel and brass hardware, it is essential for storing cushions and objects.

IT Il baule che completa la linea è caratterizzato da un ripiano regolabile, realizzato in teak massello con ferramenta in acciaio inox e ottone. Fondamentale per riporre cuscini ed oggetti.

FR Le coffre qui complète cette ligne se caractérise par une tablette intérieure réglable et une double ouverture supérieure et frontale. Réalisé en teck massif et doté d'une quincaillerie en acier inoxydable et en laiton, il est très pratique pour ranger les coussins et des objets.

- Teak / Teak / Teck
- Removable cushions col. standard Latte 04 / Cuscini sfoderabili col. standard Latte 04 / Coussins déhoussables col. standard Latte 04
- Canatex / Canatex / Canatex
- Plastic fabric / Tessuto plastico / Tissu plastique

Sitting / Sedute / Assises

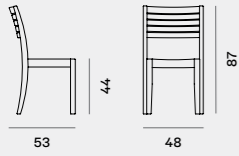

Chair / Sedia / Chaise
SEBRI

CUSBRIA
Cushion / Cuscino / Coussin

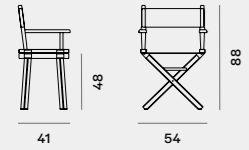

Small armchair / Poltroncina / Petit fauteuil

GINPOST
structure / struttura / structure

GINTEL
Cover and cushion in 100% cotton / Teli e cuscino di cotone 100% / Toile et coussin 100% coton de couleur Coton

GITECAN
Cover Canatex beige / Telo di Canatex beige / Toile en Canatex beige

GINTEXBI
Cover quilted plastic fabric white / Telo di tessuto plastico trapuntato bianco / Toile en tissu plastique matelassé blanc

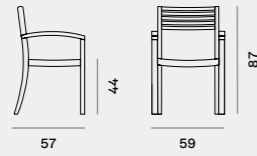

Small armchair / Poltroncina / Petit fauteuil
BRISE

CUSBRIA
Cushion / Cuscino / Coussin

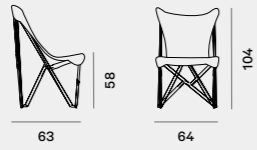

Small armchair / Poltroncina / Petit fauteuil

EMY
Structure / Struttura / Structure

EMYTEL
Sling in 100% cotton / Telo di cotone 100% / Toile 100% coton de couleur Coton

EMYTPA
Sling in leather orange / Telo di pelle arancio / Toiles en cuir orange

EMYTPV
Sling in leather green / Telo di pelle verde / Toiles en cuir vert

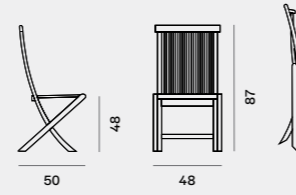

Chair / Sedia / Chaise
WILSED

CUSEDA
Cushion / Cuscino / Coussin

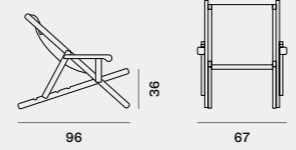

Deckchair with sling in 100% cotton / Sdraio con telo di cotone 100% / Transat avec toile 100% coton de couleur coton
CLI

CLIOTEL
Spare sling / Telo di ricambio / Toile de rechange

- Teak / Teak / Teck
- Removable cushions col. standard Latte 04 / Cuscini sfoderabili col. standard Latte 04 / Coussins déhoussables col. standard Latte 04
- Canatex / Canatex / Canatex
- Plastic fabric / Tessuto plastico / Tissu plastique

Lounge / Lounge / Lounge

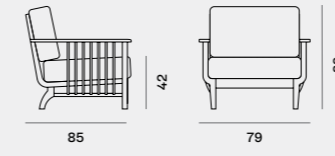

Armchair / Poltrona / Fauteuil
CHPO

CHCU
Set of cushions / Set di cuscini / Set de coussins

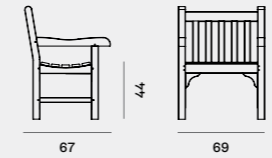

Armchair / Poltrona / Fauteuil
GRPOL

CUSPLOLGRA
Cushion / Cuscino / Coussin

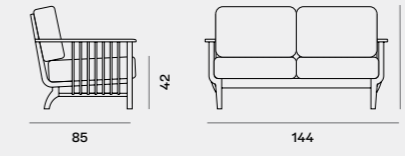

Sofa 2 seats / Divano due posti / Canapé 2 places
CHDIP

CHCU
Set of cushions / Set di cuscini / Set de coussins

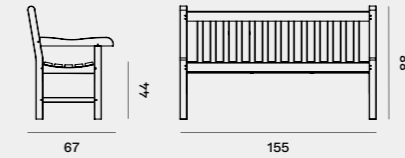

Sofa 2 seats / Divano due posti / Canapé 2 places
GRDIV15

CUDIV15A
Set of 2 cushions / Set di 2 cuscini / Set de 2 coussins

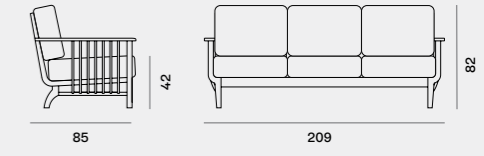

Sofa 3 seats / Divano 3 posti / Canapé 3 places
CHDIG

CHCU
Set of cushions / Set di cuscini / Set de coussins

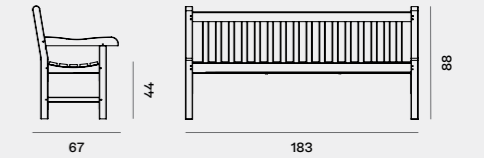

Sofa 3 seats / Divano 3 posti / Canapé 3 places
GRDIV18

CUDIV18A
Set of 3 cushions / Set di 3 cuscini / Set de 3 coussins

Sunloungers / Lettini / Bains de soleil

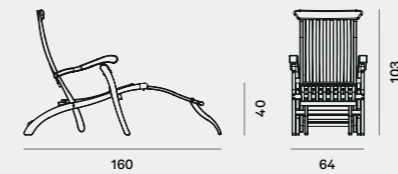

Chaise-longue / Chaise-longue / Chaise-longue
GRTIT

CUGT
Cushion / Cuscino / Coussin

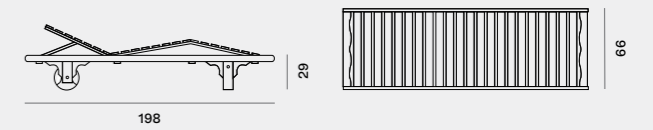

Sunlounger / Lettino / Bain de soleil
HENLETT

CUHE
Cushion / Cuscino / Coussin

- Teak / Teak / Teck
- Removable cushions col. standard Latte 04 / Cuscini sfoderabili col. standard Latte 04 / Coussins déhoussables col. standard Latte 04
- Canatex / Canatex / Canatex
- Plastic fabric / Tessuto plastico / Tissu plastique

Tables / Tavoli / Tables



Table extendable / Tavolo allungabile / Table allongeable
TAMIREP

Table extendable / Tavolo allungabile / Table allongeable
TAMILRE

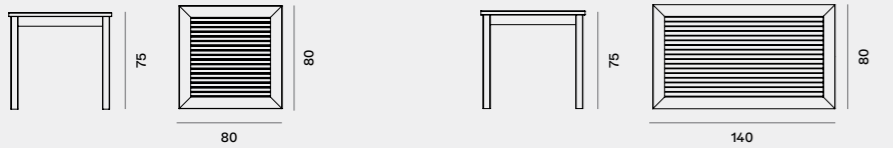

Square table / Tavolo quadrato /
Table carré
LOTAVQ

Rectangular table / Tavolo rettangolare /
Table rectangulaire
LOTAVR

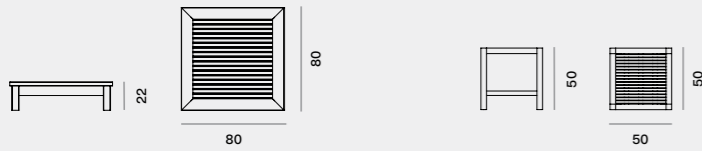

Square coffee table / Tavolino /
Table basse carré
CHETAQ

Square coffee table / Tavolino /
Table basse carré
MOTAQB

Chest / Baule / Coffre *

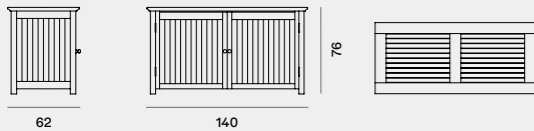

Chest with 2 doors and 1 adjustable shelf / Baule con 2 sportelli e 1
ripiano regolabile / Coffre avec 2 portes et 1 étagère réglable
BAUTG

* no waterproof

- Teak / Teak / Teck
- Removable cushions col. standard Latte 04 / Cuscini sfoderabili col. standard Latte 04 / Coussins déhoussables col. standard Latte 04
- Canatex / Canatex / Canatex
- Plastic fabric / Tessuto plastico / Tissu plastique

Finishes / Finiture / Finitions

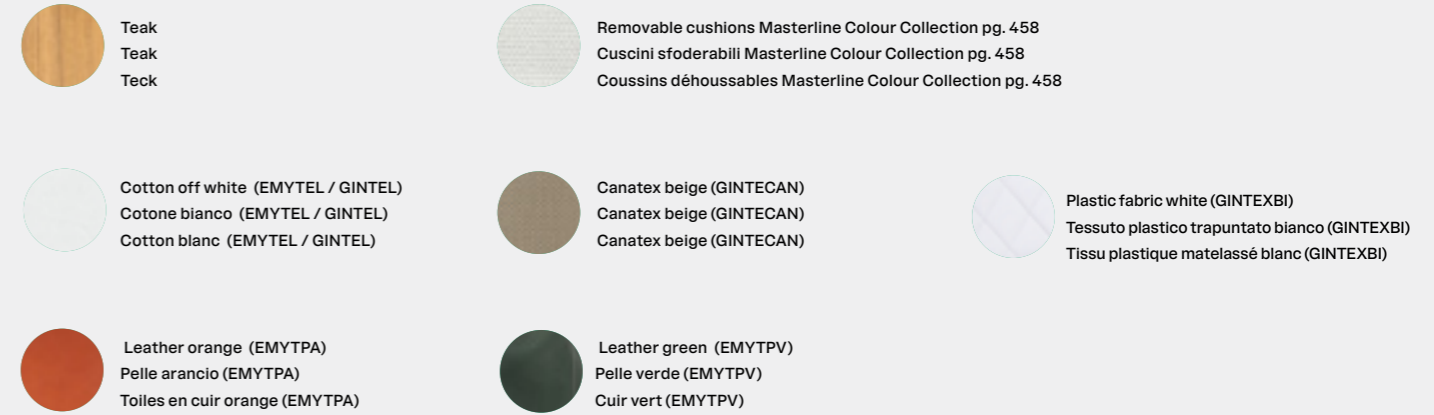

Removable cushions Masterline Colour Collection pg. 458
Cuscini sfoderabili Masterline Colour Collection pg. 458
Coussins déhoussables Masterline Colour Collection pg. 458

Canatex beige (GINTECAN)
Canatex beige (GINTECAN)
Canatex beige (GINTECAN)

Plastic fabric white (GINTEXBI)
Tessuto plastico trapuntato bianco (GINTEXBI)
Tissu plastique matelassé blanc (GINTEXBI)

Leather orange (EMYTPA)
Pelle arancio (EMYTPA)
Toiles en cuir orange (EMYTPA)

Leather green (EMYTPV)
Pelle verde (EMYTPV)
Cuir vert (EMYTPV)

Conrad

Essential lines and the stability of iron represent the compositional qualities that make Conrad the best choice for furnishing contract environments and smaller spaces.

The texture with small holes is accompanied by square, thin forms, which means the collection has a minimal, contemporary design.

IT Le linee essenziali e la stabilità del ferro rappresentano le qualità compositive che rendono Conrad la scelta più adatta per arredare ambienti contract e spazi più contenuti.

La texture dai piccoli fori si accompagna a forme squadrate e sottili, che conferiscono alla collezione un design minimale e contemporaneo.

FR Grâce à ses lignes sobres et à la stabilité apportée par le fer, Conrad est le choix idéal pour aménager les lieux d'accueil et les petits espaces. La texture perforée de petits trous et les formes carrées et fines des différents éléments confèrent à cette collection un design minimal et contemporain.







The large rectangular table can be extended thanks to a flap that folds under the half-tops, adapting to different space requirements and rendering the outdoor environment convivial.

IT L'ampio tavolo rettangolare è allungabile, adattandosi alle differenti esigenze di spazio e rendendo l'ambiente outdoor conviviale.

FR La grande table rectangulaire est extensible grâce à une rallonge à abattant qui disparaît sous les demi-plateaux, pour s'adapter aux différents besoins d'espace et en rendant l'environnement extérieur convivial.







The discreetly sized stools are available in a high version with or without backrest and in a lower version. The models are easily stackable for ease of movement.

IT Gli sgabelli dalle proporzioni discrete sono disponibili nella versione alta con o senza schienale e nella versione più bassa. I modelli sono facilmente impilabili per facilitarne lo spostamento.

FR Les tabourets aux proportions discrètes sont disponibles dans la version haute, avec ou sans dossier, et dans la version basse. Les modèles sont facilement empilables pour un déplacement facile.



- Powder coated galvanized iron / Ferro zincato verniciato a polveri / Fer galvanisé enduit de poudre
- Removable cushions col standard Latte 04 / Cuscini sfoderabili col standard Latte 04 / Coussins déhoussables col standard Latte 04

Sitting / Sedute / Assises

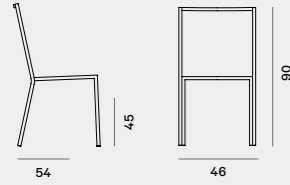

Chair / Sedia / Chaise

SELUB

White / Bianco / Blanc

SELUG

Graphite / Grafite / Graphite

CUSELU04

Cushion / Cuscino / Coussin

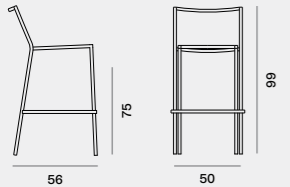

Stool / Sgabello / Tabouret

LUSGB

White / Bianco / Blanc

LUSGG

Graphite / Grafite / Graphite

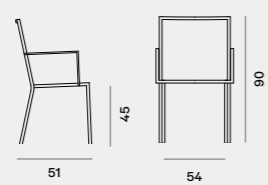

Small armchair / Poltroncina / Petit fauteuil

POLUB

White / Bianco / Blanc

POLUG

Graphite / Grafite / Graphite

CUSELU

Cushion / Cuscino / Coussin

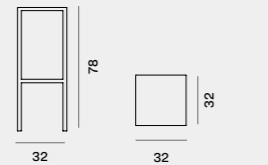

Stool / Sgabello / Tabouret

SGAACON78B

White / Bianco / Blanc

SGAACON78G

Graphite / Grafite / Graphite

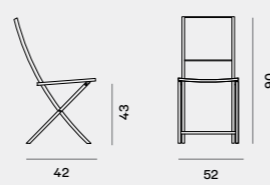

Chair / Sedia / Chaise

SENIB

White / Bianco / Blanc

SENIG

Graphite / Grafite / Graphite

CUSENI

Cushion / Cuscino / Coussin

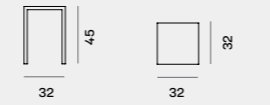

Stool / Sgabello / Tabouret

SGAACON45B

White / Bianco / Blanc

SGAACON45G

Graphite / Grafite / Graphite

Tables / Tavoli / Tables

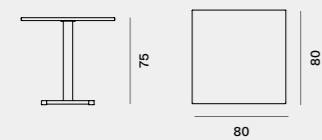

Square table / Tavolo quadrato / Table carrée

TACON80B

White / Bianco / Blanc

TACON80

Graphite / Grafite / Graphite

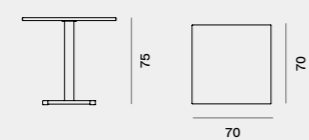

Square table / Tavolo quadrato / Table carrée

TACON70B

White / Bianco / Blanc

TACON70

Graphite / Grafite / Graphite

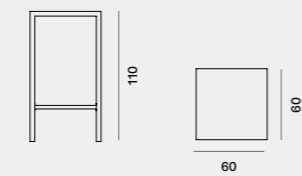

Square high table / Tavolo alto quadrato / Table haute carrè

LUTLBQ

White / Bianco / Blanc

LUTLGQ

Graphite / Grafite / Graphite

- Powder coated galvanized iron / Ferro zincato verniciato a polveri / Fer galvanisé enduit de poudre
- Removable cushions col standard Latte 04 / Cuscini sfoderabili col standard Latte 04 / Coussins déhoussables col standard Latte 04



Rectangular extendable table / Tavolo allungabile rettangolare / Table extensible rectangulaire

TACON100B

White / Bianco / Blanc

TACON100

Graphite / Grafite / Graphite

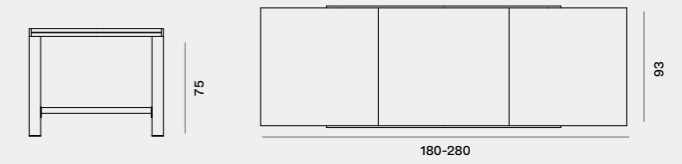

Rectangular extendable table / Tavolo allungabile rettangolare / Table extensible rectangulaire

TACON180B

White / Bianco / Blanc

TACON180

Graphite / Grafite / Graphite

Finishes / Finiture / Finitions

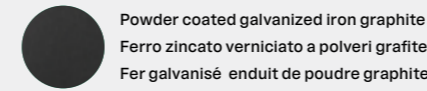

Powder coated galvanized iron graphite
Ferro zincato verniciato a polveri grafite
Fer galvanisé enduit de poudre graphite



Removable cushions col. Latte 04
Cuscini sfoderabili col. Latte 04
Coussins déhoussables col. Latte 04



Powder coated galvanized iron white
Ferro zincato verniciato a polveri bianco
Fer galvanisé enduit de poudre blanc

M Experience

The monochromatic collection is characterised by a combination of graphite-coloured aluminium and synthetic fibre, expertly woven by hand. The light, slender structure mixed with the craftsmanship of the weave make Experience an elegant, sophisticated line.

IT La collezione monocromatica è caratterizzata dall'accostamento di alluminio color grafite e fibra sintetica, sapientemente tessuta a mano. La struttura leggera e slanciata mescolata all'artigianalità dell'intreccio, rendono Experience una linea elegante e raffinata.

FR Cette collection monochrome se caractérise par l'alliance de l'aluminium de couleur graphite et de la fibre synthétique soigneusement réalisée à la main. La structure légère et élancée et le tressage de style artisanal apportent une touche élégante et raffinée à la ligne Experience.









The backrest and seat of the armchair made of hand-woven WaProLace® fibre have softer, more rounded shapes, while the curved backrest, in particular, confers comfort and harmony.

IT Lo schienale e la seduta della poltroncina in fibra WaProLace® intrecciata a mano, si distinguono per forme più morbide e circolari, in particolare lo schienale curvilineo conferisce comfort ed armonia.

FR Le dossier et l'assise du fauteuil en fibre WaProLace® tissée à la main se distinguent par des formes plus douces et plus circulaires, en particulier le dossier incurvé lui confère confort et harmonie.





The loungers with reclining backs have simple, clean lines, and allow the tilting angle to be adjusted as needed, so as to enjoy your moment of relaxation to the fullest.

IT Linee essenziali e pulite caratterizzano i lettini dallo schienale reclinabile, offrendo la possibilità di regolarne l'inclinazione in base all'occorrenza, godendosi al meglio il proprio momento di relax.

FR Des lignes essentielles et épurées caractérisent les chaises longues à dossier inclinable, offrant la possibilité d'ajuster l'inclinaison en fonction des besoins, pour profiter au maximum de votre moment de détente.

M Experience

- Aluminum / Alluminio/ Aluminium
- WaProLace® synthetic fibre / Fibra sintetica WaProLace® / Fibre synthétique WaProLace®
- Removable cushions col standard Diamante 001 / Cuscini sfoderabili col standard Diamante 001 / Coussins déhoussables col standard Diamante 001

Sitting / Sedute / Assises

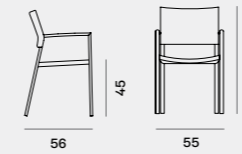

Chair / Sedia / Chaise
JOSEG

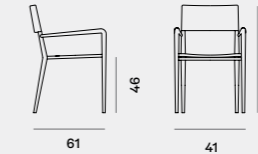

Small armchair / Poltroncina / Petit fauteuil
EXLSEI

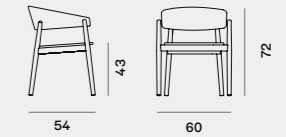

Small armchair / Poltroncina / Petit fauteuil
EXLPOGW

Lounge / Lounge / Lounge

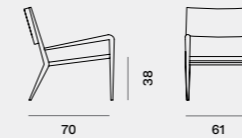

Armchair / Poltrona / Fauteuil
EXLPO

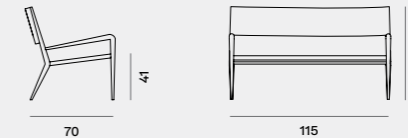

Sofa / Divano / Canapé
EXLDIV

Sunlounge / Lettini / Bain de soleil

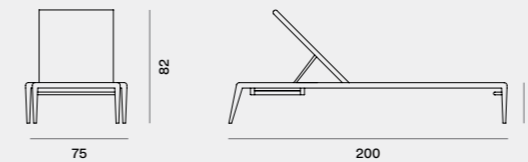

Sunlounger / Lettino / Bain de soleil
EXLET

CUEXLET001

Cushion / Cuscino / Coussin

Tables / Tavoli / Tables

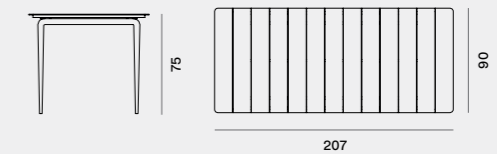

Rectangular table / Tavolo rettangolare /
Table rectangulaire
EXTALVA

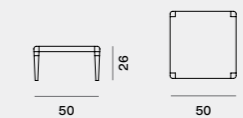

Square coffee table / Tavolino quadrato /
Table basse carré
EXTALQ

Finishes / Finiture / Finitions

WaProLace® antique brown
WaProLace® antique brown
WaProLace® antique brown

Aluminum graphite
Alluminio grafite
Aluminium graphite

Removable cushions col. Diamante 001
Cuscini sfoderabili col. Diamante 001
Coussins déhoussables col. Diamante 001

Les Arcs

Les Arcs is a collection that has been created around the use of aluminium tubing as a common element.

Les Arcs offers the utmost compositional freedom, with modules that can be combined as desired, according to needs.

IT Les Arcs è una collezione che si articola intorno all'utilizzo del tubolare di alluminio come elemento connotativo.

Les Arcs offre la massima libertà compositiva, con moduli da combinare a piacere in base alle esigenze.

FR Les Arcs est une collection basée sur l'utilisation d'un élément caractéristique : le tube en aluminium. Les Arcs offre une totale liberté au niveau de la composition, proposant des modules à combiner en fonction des exigences.

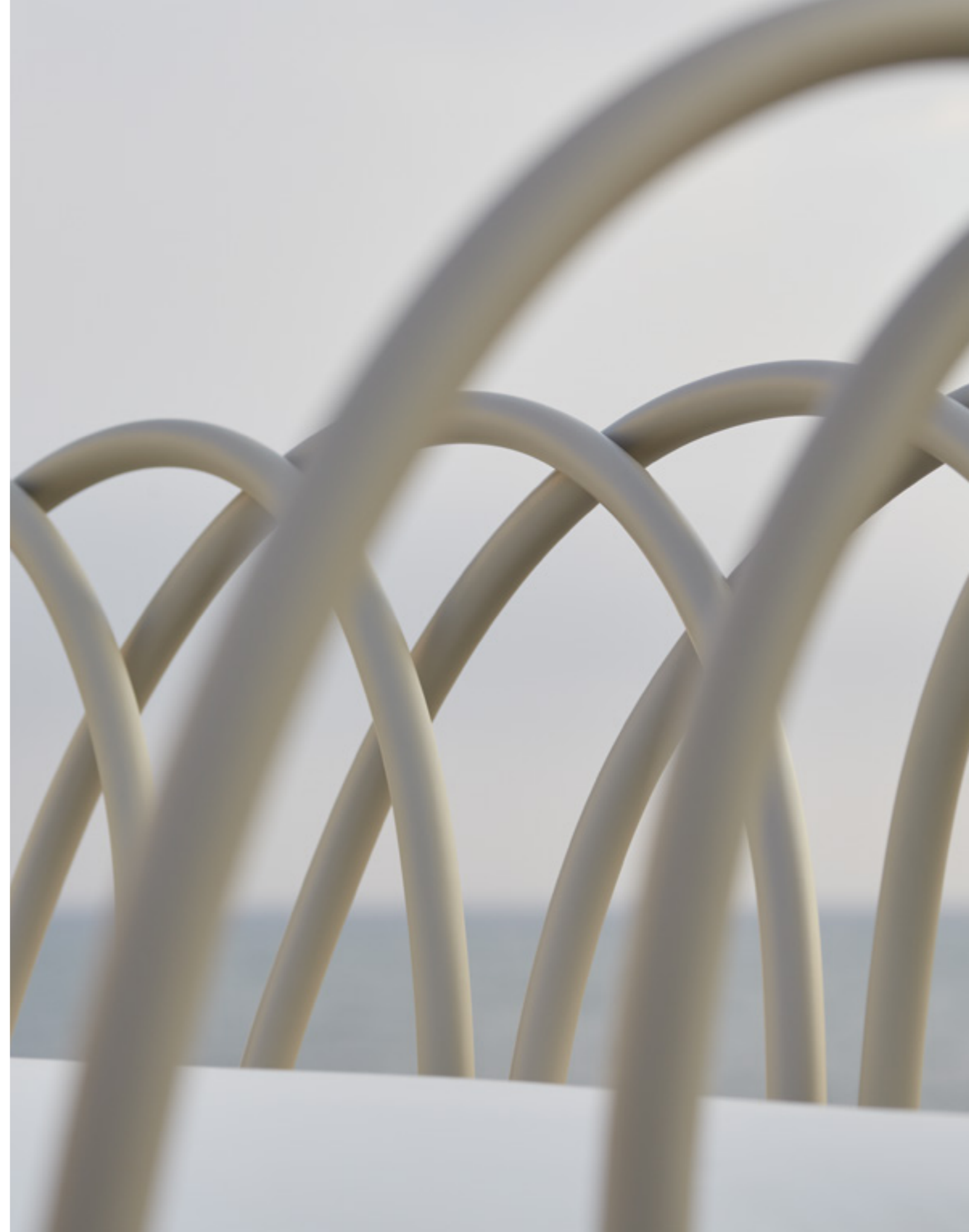





The sofa modules can be combined with low coffee tables, featuring square, rectangular shapes, both of which are extremely light and harmoniously complete the collection.

IT I moduli dei divani possono essere combinati con i tavolini bassi, dalla forma quadrata e rettangolare, entrambi estremamente leggeri completano con armonia la collezione.

FR Les modules des canapés peuvent être combinés avec les tables basses, de forme carrée et rectangulaire, toutes deux extrêmement légères et qui complètent harmonieusement la collection.





The curved, elegant shapes of the intertwined arches reinterpret the historical line made of rope and teak, generating a dialogue between tradition and modernity.

IT Le forme curve ed eleganti degli archi intrecciati reinterpretano la storica linea in corda e teak, generando un dialogo tra tradizione e contemporaneità.

FR Les formes courbes et élégantes des arcs tressés réinterprètent la ligne historique en corde et en teck, générant un dialogue entre la tradition et la modernité.





The upholstered system complements tables and chairs with a fresh, contemporary design.

IT Al sistema di imbottiti si abbinano tavoli e sedute dal design fresco e contemporaneo.

FR Les éléments matelassés sont complétés de tables et de sièges au design frais et contemporain.





The bench incorporates the curved and enveloping shapes of all the other furnishings. The armrests, backrest and front legs form a single delicate, sinuous line.

IT La panca riprende le forme curvilinee ed avvolgenti caratteristiche di tutti gli arredi. I braccioli costruiscono con lo schienale e le gambe anteriori un'unica linea delicata e sinuosa.

FR La banc reprend les formes curvilignes et enveloppantes caractéristiques de tous les meubles. Les accoudoirs forment une seule ligne délicate et sinieuse avec le dossier et les pieds avant.



- Aluminum tubular / Tubolare di alluminio / Tubulaire en aluminium
- Removable cushions col standard Diamante 001 / Cuscini sfoderabili col standard Diamante 001 / Coussins déhoussables col standard Diamante 001

Configurations / Configurazioni / Configurations

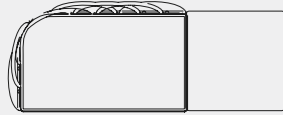

Single Linear / Lineare singolo / Linéaire single

Rt Module + square coffee table /
Modulo dx + tavolo quadrato /
Module d + table basse carré

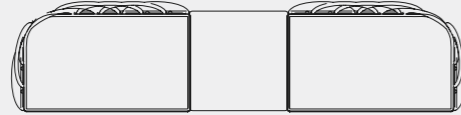

Double linear / Lineare doppio / Linéaire double

Rt module + square coffee table + lt module /
Modulo dx + tavolo quadrato + modulo sx /
Module d + table basse carré + module g

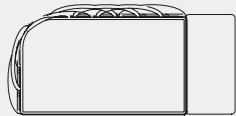

Single linear / Lineare singolo / Linéaire single

Rt Module + rectangular coffee table /
Modulo dx + tavolo rettangolare /
Module d + table basse rectangulaire

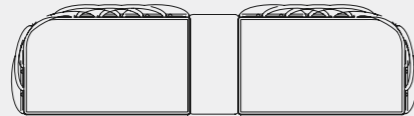

Double Linear / Lineare doppio / Linéaire duple

Rt module + rectangular coffee table + lt module /
Modulo dx + tavolo rettangolare + modulo sx /
Module d + table basse rectangulaire + module g

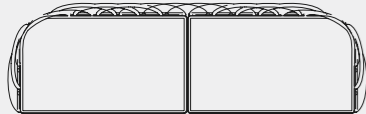

Double linear / Lineare doppio / Linéaire double

Rt module + lt module / Modulo dx + modulo sx /
Module d + module g

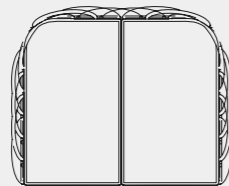

Double linear / Lineare doppio / Linéaire double

Lt module + rt module / Modulo sx + modulo dx /
Module g + module d

- Aluminum tubular / Tubolare di alluminio / Tubulaire en aluminium
- Removable cushions col standard Diamante 001 / Cuscini sfoderabili col standard Diamante 001 / Coussins déhoussables col standard Diamante 001

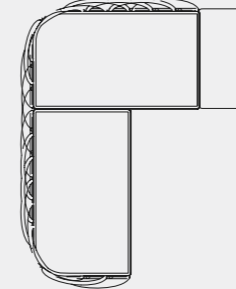

L single / L singola / L single

Rt module + rectangular coffee table + rt module /
Modulo dx + tavolo rettangolare + modulo dx /
Module d + table basse rectangulaire + module d

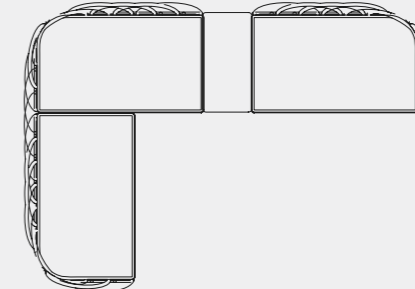

L double / L doppia / L double

N 2 rt modules + rectangular coffee table + lt module /
N 2 moduli dx + tavolo rettangolare + modulo sx /
N 2 modules d + table basse rectangulaire + module g

Finishes / Finiture / Finitions

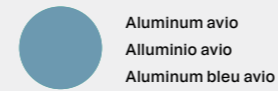

Aluminum avio
Alluminio avio
Aluminum bleu avio

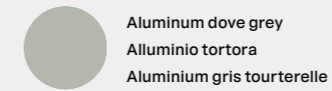

Aluminum dove grey
Alluminio tortora
Aluminium gris tourterelle

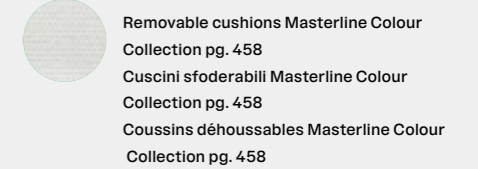

Removable cushions Masterline Colour
Collection pg. 458
Cuscini sfoderabili Masterline Colour
Collection pg. 458
Coussins déhoussables Masterline Colour
Collection pg. 458

Colours made to order / Colori su richiesta / Couleurs sur demande

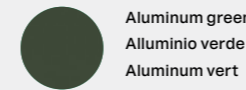

Aluminum green
Alluminio verde
Aluminum vert

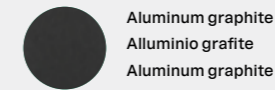

Aluminum graphite
Alluminio grafite
Aluminum graphite

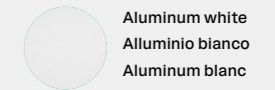

Aluminum white
Alluminio bianco
Aluminum blanc

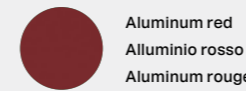

Aluminum red
Alluminio rosso
Aluminum rouge

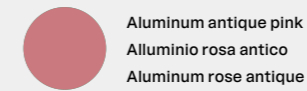

Aluminum antique pink
Alluminio rosa antico
Aluminum rose antique

The encounter of the frame made from aluminium and the synthetic rope covering the armrests and backrest has produced Luce, a name inspired by the lighting effects generated by the combination of the two materials.

IT Dall'incontro tra l'alluminio della struttura e la corda sintetica con cui sono rivestiti i braccioli e lo schienale, nasce Luce, il cui nome si ispira agli effetti luminosi che la combinazione dei due materiali genera.

FR La rencontre entre l'aluminium de la structure et la corde synthétique qui revêt les accoudoirs et le dossier donnent naissance à Luce, dont le nom s'inspire des effets lumineux générés par la combinaison des deux matériaux.







The tapered legs, which become even more slender at the ends, are a feature of the line, conferring a sense of lightness to the furnishings without sacrificing the stability and solidity guaranteed by the aluminium.

IT Le gambe rastremate, che tendono ad assottigliarsi all'estremità sono la peculiarità della linea, conferendo leggerezza agli arredi senza rinunciare alla stabilità e solidità garantita dall'alluminio.

FR Les pieds fuselés, qui ont tendance à se rétrécir aux extrémités, sont la particularité de la ligne, conférant de la légèreté à l'ameublement sans sacrifier la stabilité et la solidité garantie par l'aluminium.







The coffee tables are available in round or square shapes. The aluminium top allows you to freely configure your outdoor area.

IT I tavolini sono disponibili nella forma rotonda o quadrata. Il piano in alluminio lascia libertà di configurare a piacere il proprio outdoor.

FR Les tables sont disponibles en forme ronde ou carrée. Le plateau en aluminium permet de configurer librement votre espace extérieur.

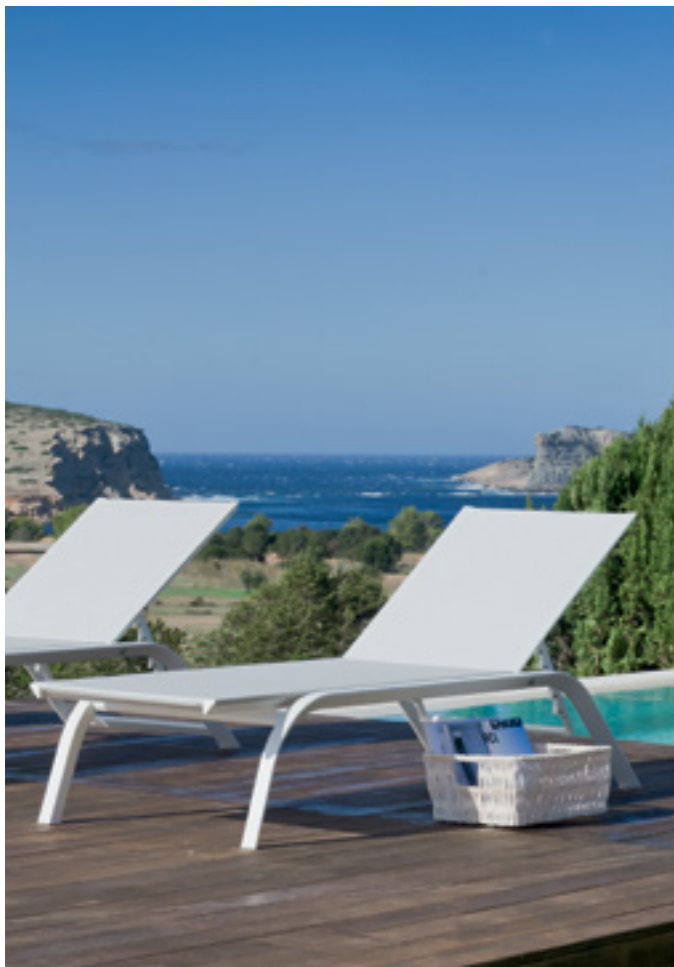

The lounge is made from a technical fabric that combines the resistance of PVC with the softness of the weft made from polyester chenille. Available in bronze and white.

IT Il lettino è realizzato con un tessuto tecnico che unisce la resistenza del PVC alla morbidezza della trama composta da ciniglia di poliestere. Disponibile in colore bronzo e bianco.

FR Le transat est réalisé à partir d'un tissu technique qui allie la résistance du PVC à la souplesse de la trame composée de chenille en polyester. Disponible en couleur bronze et blanc.



- Aluminum tubular / Tubolare di alluminio / Tubulaire en aluminium
- Polyolefin cord / Corda poliolefinica / Cordon polyoléfine
- Removable cushions col standard Latte 04 / Cuscini sfoderabili col standard Latte 04 / Coussins déhoussables col standard Latte 04

Sitting and Lounge / Sedute e Lounge / Assises et Lounge

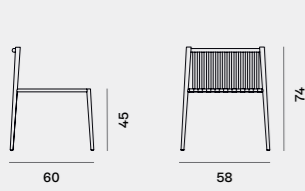

Chair / Sedia / Chaise
LUNSBG

LUCUSB
Cushion / Cuscino / Coussin

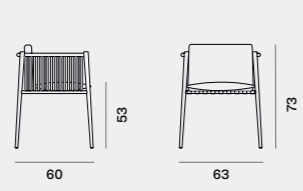

Small armchair / Poltroncina / Petit fauteuil
LUNSEG

LUCUSE
Cushion / Cuscino / Coussin

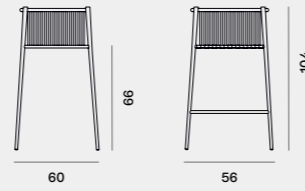

Stool / Sgabello / Tabouret
LUNSGAG

LUCUSGA
Cushion / Cuscino / Coussin

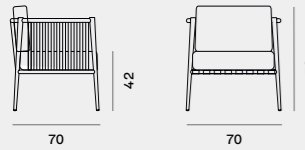

Armchair / Poltrona / Fauteuil
LUNPOG

LUCUPO
Cushion / Cuscino / Coussin

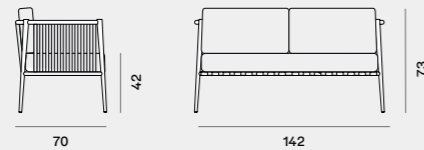

Sofa / Divano / Canapé
LUNDIG

LUCUDI
Cushion / Cuscino / Coussin

Sunlounger / Lettini / Bains de soleil

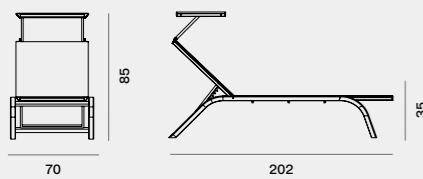

Sunlounger / Lettino / Bain de soleil

PANLEBB
White / Bianco / Blanc

PANLEBRM
Bronze / Bronzo / Bronze

PANTELBB
Canopy white / Tettuccio bianco / Toit blanc

PANTELBRM
Canopy bronze / Tettuccio bronzo / Toit bronze

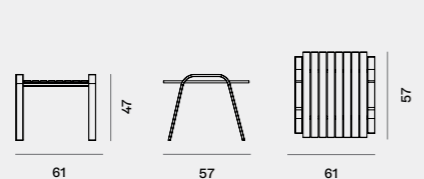

Coffe table / Tavolino / Table basse

PANTBBI
White / Bianco / Blanc

PANTBBR
Bronze / Bronzo / Bronze

- Aluminum tubular / Tubolare di alluminio / Tubulaire en aluminium
- Polyolefin cord / Corda poliolefinica / Cordon polyoléfine
- Removable cushions col standard Latte 04 / Cuscini sfoderabili col standard Latte 04 / Coussins déhoussables col standard Latte 04

Tables / Tavoli / Tables

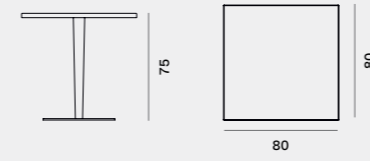

Square table / Tavolo quadrato / Table carré
LUNTAQU80G

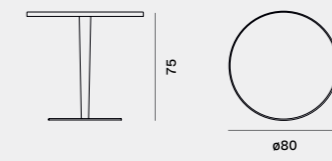

Round table / Tavolo rotondo / Table ronde
LUNTARO80G

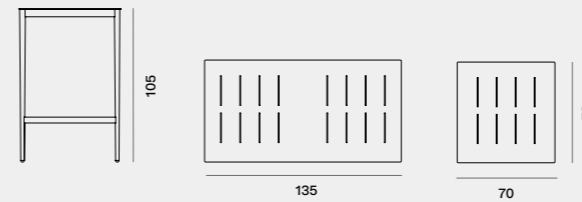

Tall table rectangular / Tavolo alto rettangolare / Table haute rectangulaire
LUNTABAREG

Tall table square / Tavolo alto quadrato / Table haute carrée
LUNTABAQUG

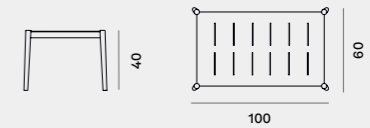

Rectangular coffee table / Tavolino rettangolare / Table basse rectangulaire
LUNTBRG

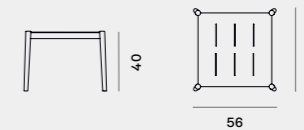

Coffee table / Tavolo basso / Table basse
LUNTBQGG

Finishes / Finiture / Finitions

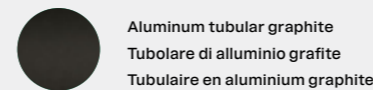

Aluminum tubular graphite
Tubolare di alluminio grafite
Tubulaire en aluminium graphite

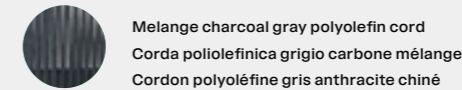

Melange charcoal gray polyolefin cord
Corda poliolefinica grigio carbone mélange
Cordon polyoléfine gris anthracite chiné

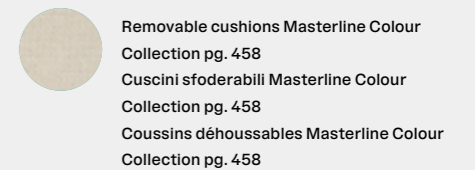

Removable cushions Masterline Colour
Collection pg. 458
Cuscini sfoderabili Masterline Colour
Collection pg. 458
Coussins déhoussables Masterline Colour
Collection pg. 458

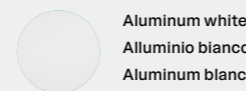

Aluminum white
Alluminio bianco
Aluminium blanc

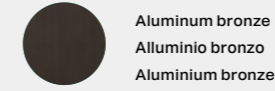

Aluminum bronze
Alluminio bronzo
Aluminium bronze

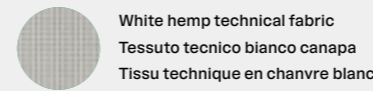

White hemp technical fabric
Tessuto tecnico bianco canapa
Tissu technique en chanvre blanc

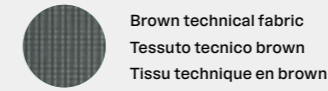

Brown technical fabric
Tessuto tecnico brown
Tissu technique en brown

Olimpia

The collection is a reinterpretation of traditional Mediterranean lines. The soft, sinuous shapes can be found in all the elements in the series, the characteristic feature of which is the weaving in hand-woven WaProLace® synthetic fibre. The elegant pattern covers the aluminium frame, enhancing its voluptuous, enveloping shapes.

IT La collezione nasce come rivisitazione delle linee tradizionali mediterranee. Le forme dolci e sinuose ricorrono in tutti gli elementi della serie, il cui tratto caratteristico è l'intreccio in fibra sintetica WaProLace® intrecciata a mano. La trama elegante ricopre la struttura in alluminio, valorizzandone i volumi voluttuosi ed avvolgenti.

FR Cette collection revisite les lignes méditerranéennes traditionnelles. Les formes douces et sinueuses se retrouvent dans tous les éléments de la série, qui se caractérise par un tressage en fibre synthétique WaProLace® réalisé à la main. La trame élégante recouvre la structure en aluminium en mettant en valeur les formes voluptueuses et enveloppantes.









The craftsmanship and natural colouring of the weave give it a classic, discreet elegance, allowing it to interpret any outdoor style.

IT La lavorazione artigianale e la colorazione naturale dell'intreccio le conferiscono un'eleganza classica e discreta, rendendola capace di interpretare tutti gli stili dell'outdoor.

FR La fabrication artisanale et la couleur naturelle du tressage confèrent une élégance classique et discrète permettant de réinterpréter tous les styles d'aménagement extérieur.



Olimpia

- WaProLace® synthetic fibre / Fibra sintetica WaProLace® / Fibre synthétique WaProLace®
- Removable cushions col. standard Latte 04 / Cuscini sfoderabili col. standard Latte 04 / Coussins déhoussables col. standard Latte 04

Lounge / Lounge / Lounge

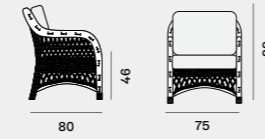

Armchair / Poltrona / Fauteuil
OLPOLW

OLCUPO
Cushion / Cuscino / Coussin

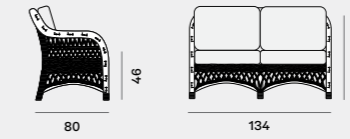

Sofa / Divano / Canapé
OLDIW2P

OLCUDI2P
Cushion / Cuscino / Coussin

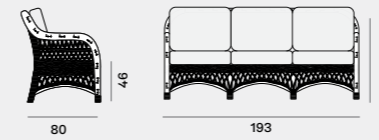

Sofa / Divano / Canapé
OLDIW3P

OLCUDI3P
Cushion / Cuscino / Coussin

Coffe table / Tavolino / Table basse



Rectangular coffee table / Tavolino rettangolare / Table basse rectangulaire
TABREOL

Finishes / Finiture / Finitions

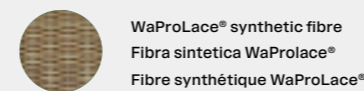

WaProLace® synthetic fibre
Fibra sintetica WaProLace®
Fibre synthétique WaProLace®



Removable cushions Masterline Colour Collection pg. 458
Cuscini sfoderabili Masterline Colour Collection pg. 458
Coussins déhoussables Masterline Colour Collection pg. 458

Pevero was created thanks to Unopiù's culture of skilfully processing teak, a precious material with excellent technical characteristics. The large, versatile collection is characterised by geometric frames and interlocking craftsmanship inspired by the Orient, enhanced by the natural finish of the wood that follows the lines and enhances its formal details.

IT Pevero nasce grazie alla sapiente cultura di Unopiù nella lavorazione del teak, materiale pregiato dalle ottime caratteristiche tecniche. La collezione ampia e versatile è caratterizzata da telai geometrici e lavorazioni ad incastro ispirate al mondo orientale, valorizzate dalla finitura naturale del legno che segue le linee e ne esalta i dettagli formali.

FR Pevero repose sur l'expertise d'Unopiù dans l'utilisation du teck, un matériau précieux aux caractéristiques techniques uniques. Cette collection vaste et polyvalente se caractérise par des toiles géométriques et des éléments encastrables s'inspirant du monde oriental, mis en valeur par la finition naturelle du bois qui suit les lignes et en exalte les détails formels.







The armchair features intertwined polypropylene yarn rope with a soft, natural colour, and a cross-section of teak wood members.

IT La poltroncina si contraddistingue per l'intreccio in corda dal colore tenue e naturale e per le assi in legno di teak dalla lavorazione a sezione circolare.

FR Le fauteuil se caractérise par l'entrelacement de la corde en fil de polypropylène d'une couleur douce et naturelle et par les lattes en bois de teck à section circulaire.





The armrests are attached to the frame thanks to a copper-effect aluminium spacer, which embellishes the large, welcoming armchair. The soft lines confer a minimal, contemporary style.

IT I braccioli si fissano alla struttura grazie ad un perno in rame, che impreziosisce la poltroncina ampia ed accogliente. Le linee morbide le conferiscono uno stile minimale e contemporaneo.

FR Les accoudoirs sont fixés à la structure grâce à une entretoise en aluminium effet cuivre, qui embellit le grand fauteuil accueillant. Les lignes douces lui confèrent un style minimaliste et contemporain.



The frame of the folding armchair, which is available in aluminium and teak, can have two types of coverings: dove grey synthetic fabric or hemp white and brown/grey mélange technical fabric. Both options guarantee utmost durability and strength against atmospheric agents.

IT La struttura della poltroncina pieghevole disponibile in alluminio e in teak, si completa con due possibili rivestimenti: in tessuto sintetico color tortora o in tessuto tecnico bianco canapa e grigio tenue. Entrambe le scelte garantiscono massima durabilità e resistenza agli agenti atmosferici.

FR La structure du fauteuil pliant, disponible en aluminium et en teck, est complétée par deux revêtements possibles : en tissu synthétique couleur gris tourterelle ou en tissu technique blanc chanvre et mélange marron/gris. Les deux choix garantissent une durabilité et une résistance maximales aux agents atmosphériques.







The seat base consists of a weave of polypropylene yarn bands, which embellish and render the entire frame more durable and ergonomic.

IT Il basamento delle sedute è composto da un intreccio di cinghie in polipropilene, che impreziosiscono e rendono l'intera struttura più resistente ed ergonomica.

FR La base de l'assise est constituée d'un entrelacement de bandes de fils de polypropylène, qui embellissent et rendent toute la structure plus résistante et ergonomique.

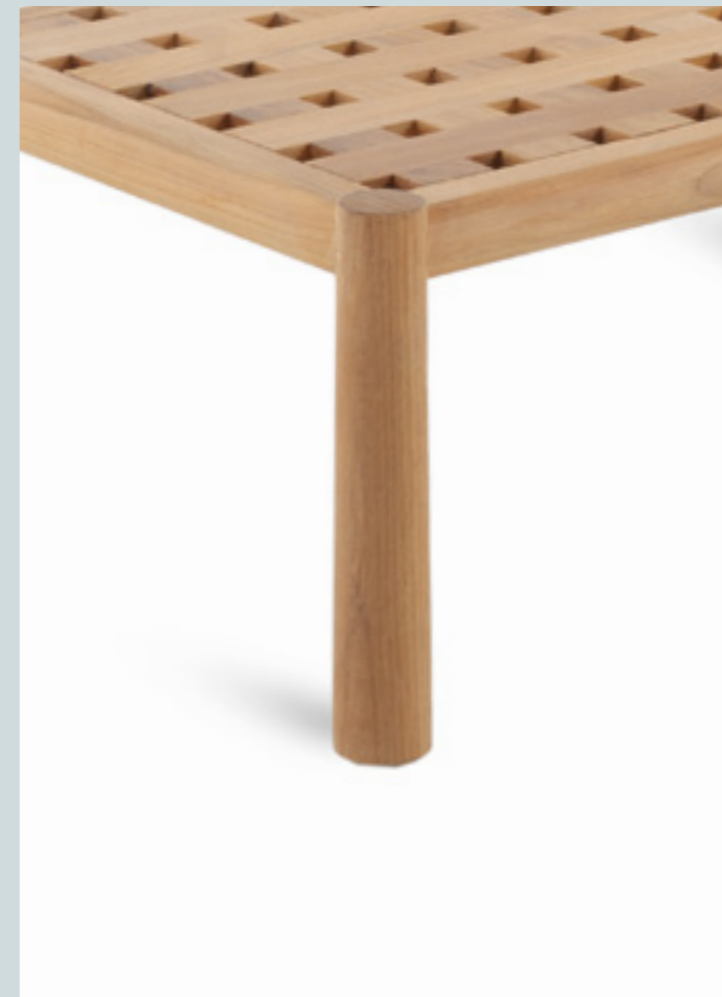

The low coffee tables feature a geometric pattern that decorates the top. Available in two sizes, rectangular and square, they can be used individually or together, adapting to any outdoor space.

IT I tavolini bassi sono caratterizzati da un pattern geometrico che decora il piano. Disponibili in due misure una rettangolare e quadrata possono essere usati singolarmente o in combinazione, adattandosi a tutti gli spazi dell'outdoor.

FR Les tables basses sont caractérisées par un motif géométrique qui décore le plateau. Disponibles en deux tailles, une rectangulaire et une carrée, elles peuvent être utilisées individuellement ou en combinaison, s'adaptant ainsi à tous les espaces extérieurs.



The ample seats with minimal lines make it ideal for environments where comfort is essential.

IT Le ampie sedute dalle linee minimali la rendono ideale per gli ambienti dove il comfort è essenziale.

FR Les larges assises aux lignes minimalistes la rendent idéale pour les environnements où le confort est essentiel.



The harmonious shapes of the island are echoed by the soft, voluminous pillow, which makes it the ideal accessory for relaxing in the shade of a tree or by the pool, in harmony with the environment. The low coffee table completes the sense of comfort with practicality, thanks to its wheels, which make it ideal for ease of movement.

IT Le forme armoniche dell'isola sono riprese dal cuscino soffice e voluminoso, che la rende l'accessorio ideale per rilassarsi all'ombra di un albero o a bordo piscina, in armonia con l'ambiente. Il tavolino basso completa il comfort con praticità, grazie alle ruote ideali per spostarlo con facilità.

FR Les formes harmonieuses de l'îlot sont tirées du coussin moelleux et volumineux, ce qui en fait l'accessoire idéal pour se détendre à l'ombre d'un arbre ou au bord de la piscine, en harmonie avec l'environnement. La table basse complète le confort avec praticité, grâce aux roues idéales pour la déplacer facilement.





The legs of the bed harmoniously incorporate the soft curves of the collection, creating a single body with the base. The polyester chenille sheet in shades of white elegantly completes the adjustable frame.

IT Il piedino del lettino riprende armoniosamente le curve morbide della collezione, creando un corpo unico con il basamento. Il telo in textilene bianco completa con eleganza la struttura regolabile.

FR Le pied de la chaise longue intègre harmonieusement les courbes douces de la collection, créant un corps unique avec la base. La toile chenille en polyester dans les tons de blanc complète avec élégance la structure réglable.



- Teak / Teak / Teck
- Technical fabric / Tessuto tecnico / Tissu technique
- Polypropylene fabric / Tessuto polipropilene / Tissu polypropylène
- Removable cushions col. standard Diamante 001 / Cuscini sfoderabili col. standard Diamante 001 / Coussins déhoussables col. standard Diamante 001

Sitting / Sedute / Assises

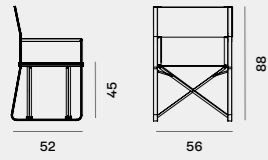

Small armchair / Poltroncina / Petit fauteuil

COPOLB

White / Bianco / Blanc

COPOLG

Graphite / Grafite / Graphite

OCTELB

Cover hemp white / Telo bianco canapa / Toile blanc chanvre

OCTELBR

Cover brown / Telo brown / Toile marron

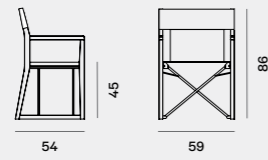

Small armchair / Poltroncina / Petit fauteuil

COPOL

COPOLT

Cover dove grey / Telo tortora / Toile tourterelle

COPOLB

Cover hemp white / Telo bianco canapa / Toile blanc chanvre

COPOLM

Cover brown / Telo brown / Toile marron

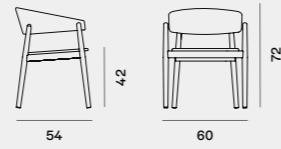

Small armchair in teak and cord / Poltroncina in teak e corda / Petit fauteuil en teck et corde

PEVSETC

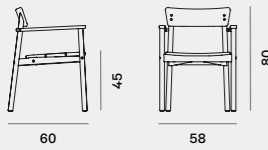

Small armchair / Poltroncina / Petit fauteuil

PEVSETE

CUPEVSE

Cushion / Cuscino / Coussin

Lounge / Lounge / Lounge

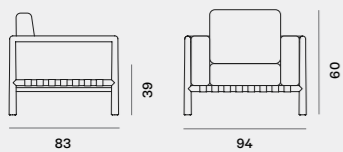

Armchair / Poltrona / Fauteuil

PEVPOL

CUPEVPOL

Cushion / Cuscino / Coussin

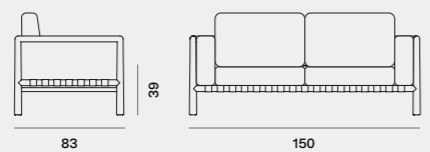

Sofa 2 seats / Divano 2 posti / Canapé 2 places

PEVDI2P

CUPEVDI2P

Set of cushions / Set di cuscini / Set de coussins

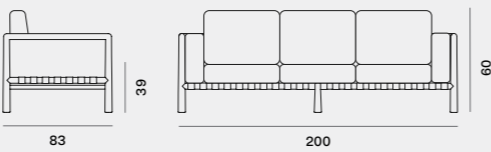

Sofa 3 seats / Divano 3 posti / Canapé 3 places

PEVDI3P

CUPEVDI3P

Set of cushions / Set di cuscini / Set de coussins

- Teak / Teak / Teck
- Technical fabric / Tessuto tecnico / Tissu technique
- Polypropylene fabric / Tessuto polipropilene / Tissu polypropylène
- Removable cushions col. standard Diamante 001 / Cuscini sfoderabili col. standard Diamante 001 / Coussins déhoussables col. standard Diamante 001

Sunloungers / Lettini / Bains de soleil

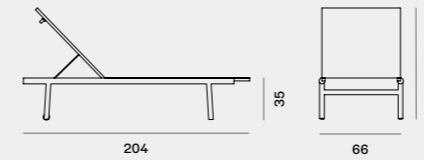

Sunlounger / Lettino / Bain de soleil

PEVLET

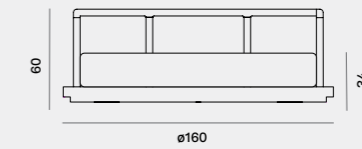

Island / Isola / Îlot

PEVISO

CUPEVISO

Cushion / Cuscino / Coussin

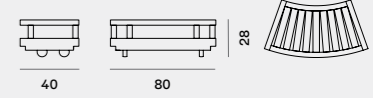

Island table / Tavolino / Table basse

PEVISOTB

Tables / Tavoli / Tables

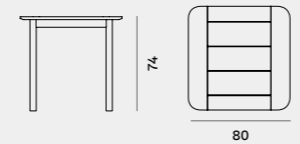

Square table / Tavolo quadrato / Table carrée

PEVTAQ80

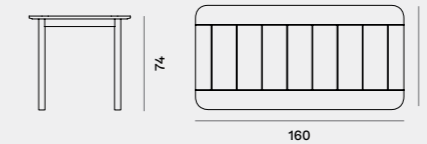

Rectangular table / Tavolo rettangolare / Table rectangulaire

PEVTARE160

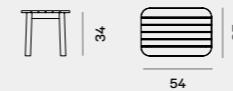

Rectangular coffee table / Tavolino rettangolare / Table basse rectangulaire

PEVSTAB



Square coffee table / Tavolino quadrato / Table basse carrée

PEVTBQ



Rectangular coffee table / Tavolino rettangolare / Table basse rectangulaire

PEVTBR

Finishes / Finiture / Finitions



Teak
Teak
Teck



Polyester chenille
Ciniglia di poliestere
Chenille en polyester



Brown technical fabric
Tessuto tecnico brown
Tissu technique en brown



Dove grey polypropylene fabric
Tessuto polipropilene tortora
Tissu polypropylène taupe



Removable cushions Masterline Colour
Collection pg. 458
Cuscini sfoderabili Masterline Colour
Collection pg. 458
Coussins déhoussables Masterline Colour
Collection pg. 458



Aluminum white
Alluminio bianco
Aluminium blanc



Aluminum graphite
Alluminio grafite
Aluminium graphite

M Synthesis

Synthesis is a contemporary collection with a basic design, where the purity of the lines is conveyed through an elegant combination of teak and hand-woven WaProlace® synthetic fibre.

Craftsmanship and attention to detail are the distinctive traits of the many products in the collection.

IT Synthesis è una collezione contemporanea dal design essenziale, dove la purezza delle linee viene raccontata attraverso l'elegante connubio di teak e fibra sintetica WaProlace® intrecciata a mano. La lavorazione artigianale e la cura del dettaglio sono i tratti identificativi di cui si compongono i molteplici prodotti della collezione.

FR Synthesis est une collection contemporaine au design sobre offrant des lignes pures, grâce à l'alliance élégante du teck et la fibre synthétique WaProlace® tressée à la main.

La fabrication artisanale et l'attention au détail caractérisent les nombreux produits de cette collection.

The wide mesh weave of the fibre combines functionality and aesthetics in a discreet, sophisticated pattern designed to harmoniously complement the natural space.

IT L'intreccio a maglie larghe della fibra coniuga funzionalità ed estetica in un motivo discreto e sofisticato, concepito per adattarsi armoniosamente con lo spazio naturale.

FR Le tressage à larges mailles de la fibre conjugue fonctionnalité et esthétique dans un motif discret et raffiné, conçu pour s'intégrer harmonieusement à l'espace naturel.







The lounge armchair, featuring a square, oblique leg that renders it stable, a slightly curved backrest attached to the seat, providing continuity, and handles on the side that allow it to be moved and stacked easily.

IT La poltrona lounge è caratterizzata da gamba squadrata e obliqua che la rende stabile, uno schienale leggermente curvo che si unisce alla seduta dando continuità e maniglie a lato per spostarla e impilarla con facilità.

FR Le fauteuil lounge présente des pieds carrés et obliques qui renforcent sa stabilité, un dossier légèrement incurvé qui s'unit à l'assise et la prolonge ainsi que des poignées latérales permettant de le déplacer et de l'empiler avec facilité.



The slatted top and the squared teak legs lend a compact solidity to the pouf.

IT Il piano in doghe e il piedino squadrato in teak conferiscono una solidità compatta al pouf.

FR La base en lattes et les pieds carrés en teck assurent la solidité du pouf de forme compacte.





The armrest with amply spaced teak slats emphasises the welcoming, wide seat of the armchair with short, square legs and an adjustable fibre backrest, like the one on the lounge and the folding deckchair.

IT Il bracciolo con doghe in teak ampiamente distanziate, sottolinea l'accogliente e ampia seduta della poltrona dai piedini squadrati e corti e lo schienale regolabile in fibra, come quello del lettino e della sdraio pieghevole.

FR L'accoudoir composé de lattes en teck très espacées vient compléter l'assise large et accueillante de ce fauteuil aux pieds carrés et courts et au dossier réglable en fibre, comme celui du transat et de la chaise-longue pliable.



Synthesis is characterised by its versatility and ability to adapt to multiple living solutions. Thanks to the use of fine materials and careful workmanship, the collection transforms each room into an elegant, sophisticated and contemporary landscape.

IT Synthesis si caratterizza per la sua versatilità e capacità di adattarsi a molteplici soluzioni abitative. Attraverso l'uso di materiali pregiati e l'accurata lavorazione la collezione trasforma ciascun ambiente in un paesaggio elegante, sofisticato e contemporaneo.

FR Synthesis se distingue par sa polyvalence et sa capacité à s'adapter à de multiples solutions d'aménagement. Composée de matériaux précieux et se caractérisant par le soin apporté aux détails, cette collection transforme tout type d'environnement en un cadre élégant, raffiné et contemporain.







The low armchair alternates squared shapes, like those of the legs, with other rounded and curvilinear ones, like those of the backrest and seat, which instil a pleasant sensation of comfort. The seat is completed by a soft, comfortable cushion with a fully removable cover.

IT La poltroncina bassa alterna forme squadrate nelle gambe, ad altre tondeggianti e curvilinee nello schienale e seduta che infondono una piacevole sensazione di comfort. La seduta è completata dal cuscino morbido e confortevole con rivestimento interamente sfoderabile.

FR Ce fauteuil bas alterne des formes carrées, comme celle des pieds, et des formes rondes et curvilignes, comme celles du dossier et de l'assise, qui offrent une agréable sensation de confort. L'assise large est ornée d'un coussin totalement déhoussable, souple et confortable.



From the sofa to the lounge, from the chair to the coffee table and from the armchair to the alcove, it is the perfect mix of living, relaxing and dining.

IT Dal divano al lettino, dalla sedia al tavolino e dalla poltrona all'alcova è la declinazione perfetta tra living, relaxing e dining.

FR Du canapé au transat, de la chaise à la table basse et du fauteuil à l'alcôve, cette collection offre de nombreuses solutions pour créer un espace de vie parfait pour se détendre et prendre ses repas.





The loungers are adjustable from both sides and designed to meet multiple living needs.

IT I lettini sono regolabili da entrambi i lati, pensati per rispondere alle molteplici esigenze abitative.

FR Les transats, réglables de chaque côté, sont conçus pour s'adapter aux divers besoins des espaces d'habitation.



The alcove is a truly welcoming and enveloping environment. Both ends are designed to allow its use to be fully customised. The height is adjustable and can be converted into a comfortable backrest. The curtains design the exterior, filtering the sun and creating continuity between the interior space, the surrounding environment and those inhabiting it.

IT L'alcova costituisce un vero e proprio ambiente accogliente, e avvolgente. Entrambe le estremità sono pensate per lasciare piena personalizzazione nel suo utilizzo. L'altezza è regolabile e trasformabile in un comodo schienale. Le tende disegnano l'esterno, filtrando il sole e creando un continuo dialogo tra lo spazio interno, l'ambiente circostante e chi lo abita.

FR L'alcôve offre un cadre accueillant et chaleureux. Les deux extrémités sont conçues de manière à permettre une totale personnalisation de son utilisation. La hauteur est réglable et permet d'obtenir un dossier confortable. Le voilage protège de l'extérieur, filtrant le soleil et créant un dialogue continu entre l'espace interne, l'environnement et les occupants.



- Teak / Teak / Teck
- Synthetic fibre WaProLace® wicker natural / Fibra sintetica WaProLace® wicker natural / Fibre synthétique WaProLace® wicker natural
- Removable cushions col. standard Diamante 001 / Cuscini sfoderabili col. standard Diamante 001 / Coussins déhoussables col. standard Diamante 001

Sitting / Sedute / Assises

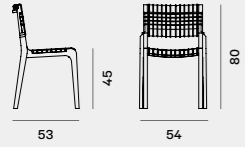

Chair / Sedia / Chaise
SESY

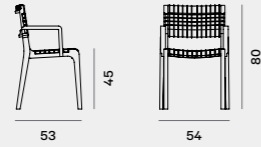

Small armchair / Poltroncina / Petit fauteuil
POSY

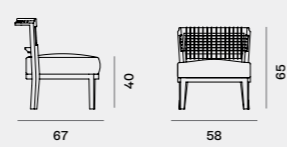

Small armchair / Poltroncina bassa / Petit fauteuil
SYPB

SYSECU
Cushion / Cuscino / Coussin

SYSECU
Cushion / Cuscino / Coussin

SYCUPB
Cushion / Cuscino / Coussin

Lounge / Lounge / Lounge

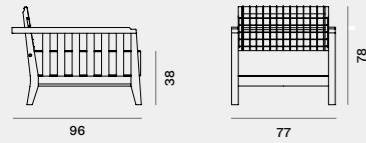

Armchair / Poltrona / Fauteuil
SYPO

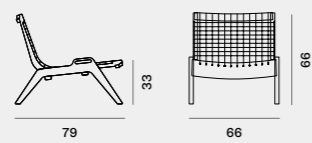

Lounge armchair stackable / Poltrona lounge impilabile / Fauteuil lounge empilabile
POLOS

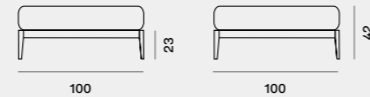

Pouf / pouf / pouf
SYPU

SYCUSE
Cushion / Cuscino / Coussin

SYPOCU
Cushion / Cuscino / Coussin

SYCUPU
Cushion / Cuscino / Coussin

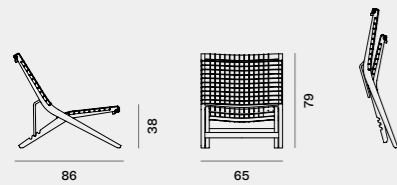

Deckchair folding / Sdraio pieghevole / Transat pliant
SDRAS

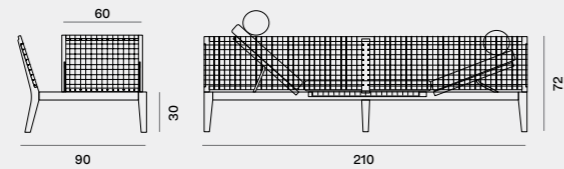

Sofa-bed adjustable seat on both sides / Divano-lettino con seduta regolabile su entrambi i lati / Canapé lit réglable des 2 côtés
SYLD

SYSDCU
Cushion / Cuscino / Coussin

SYCULD
Cushion / Cuscino / Coussin

- Teak / Teak / Teck
- Synthetic fibre WaProLace® wicker natural / Fibra sintetica WaProLace® wicker natural / Fibre synthétique WaProLace® wicker natural
- Removable cushions col. standard Diamante 001 / Cuscini sfoderabili col. standard Diamante 001 / Coussins déhoussables col. standard Diamante 001

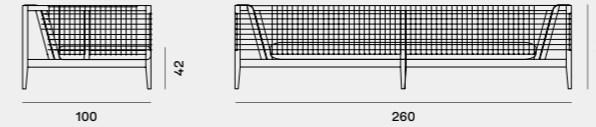

Sofa / Divano / Canapé
SYDIG

SYCUDIG
Cushion / Cuscino / Coussin

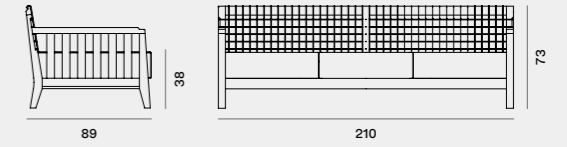

Sofa / Divano / Canapé
SYDI

SYCUSE
Cushion / Cuscino / Coussin

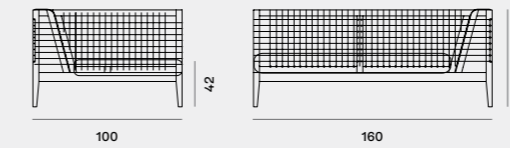

Lt corner module / Modulo angolo sx / Module g
SYANS

SYCUAN
Cushion / Cuscino / Coussin

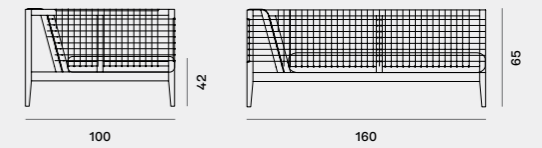

Rt corner module / Modulo angolo dx / Module d
SYAND

SYCUAN
Cushion / Cuscino / Coussin

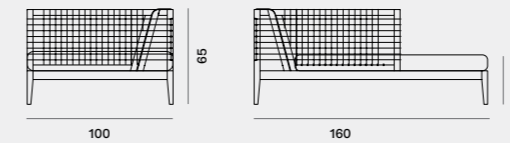

Lt chaise-longue module / Modulo chaise-longue sx / Module chaise longue g
SYCHS

SYCUCLS
Cushion / Cuscino / Coussin



Rt chaise-longue module / Modulo chaise-longue dx / Module chaise longue d
SYCHD

SYCUCLD
Cushion / Cuscino / Coussin

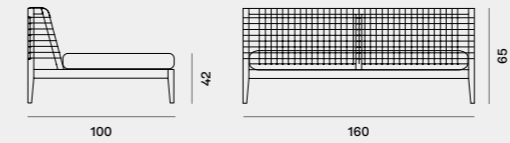

Backrest module / Modulo spalla / Module dossier
SYSP

SYCUSP
Cushion / Cuscino / Coussin

- Teak / Teak / Teck
- Synthetic fibre WaProLace® wicker natural / Fibra sintetica WaProLace® wicker natural / Fibre synthétique WaProLace® wicker natural
- Removable cushions col. standard Diamante 001 / Cuscini sfoderabili col. standard Diamante 001 / Coussins déhoussables col. standard Diamante 001

Sunloungers / Lettini / Bains de soleil

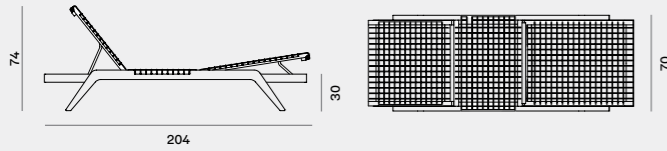

Sunlounger / Lettino / Bain de soleil
LESY



Sunlounger low / Lettino basso / Bain de soleil bas
SYLEB

SYLICU

Cushion / Cuscino / Coussin

SYCULEB

Cushion / Cuscino / Coussin

Loungebed / Letto lounge / Grand bain de soleil

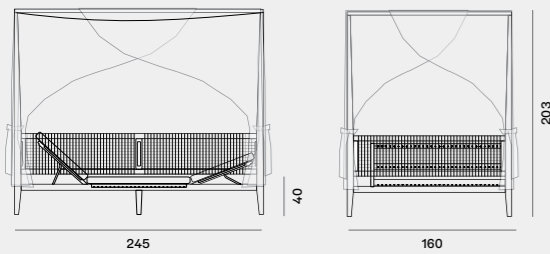

Alcove with adjustable seat base on both sides / Alcova con seduta regolabile su entrambi i lati / Alcôve avec base réglable des deux côtés
ALSYBI

Tables / Tavoli / Tables

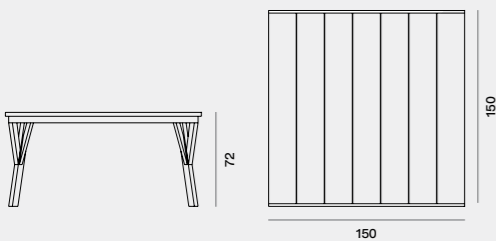

Square table / Tavolo quadrato / Table carré
TASYQU



Rectangular table extendable / Tavolo allungabile rettangolare / Table allongeable rectangulaire
TATSY

- Teak / Teak / Teck
- Synthetic fibre WaProLace® wicker natural / Fibra sintetica WaProLace® wicker natural / Fibre synthétique WaProLace® wicker natural
- Removable cushions col. standard Diamante 001 / Cuscini sfoderabili col. standard Diamante 001 / Coussins déhoussables col. standard Diamante 001

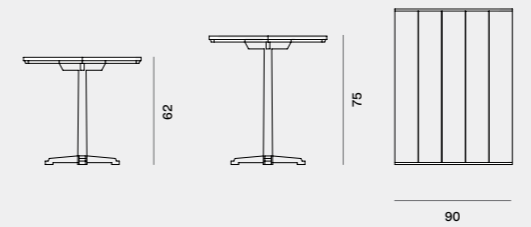

Square table / Tavolo quadrato / Table carré

TASYQB

90 x 90 H 62

TAQULESY

90 x 90 H 75

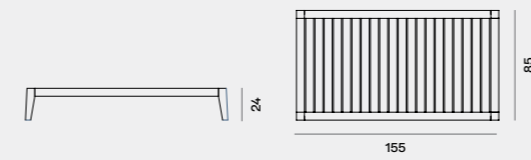

Rectangular coffee table / Tavolino rettangolare / Table basse rectangulaire
SYTABR

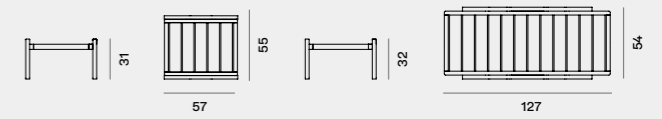

Coffee table stackable with handles / Tavolo basso impilabile con maniglie / Table basse empilable rectangulaire avec poignées

SYTABQM

Square / Quadrato / Carré

SYTABRM

Rectangular / Rettangolare / Rectangulaire

Finishes / Finiture / Finitions



Teak
Teak
Teck



WaProLace® natural
WaProLace® naturale
WaProLace® naturel



Removable cushions Masterline Colour Collection pg. 458
Cuscini sfoderabili Masterline Colour Collection pg. 458
Coussins déhoussables Masterline Colour Collection pg. 458

M Swing

The skilful crafting of thermo-curved teak wood slats gives a sinuous and welcoming look to the elements of the Swing line. The chaise-longue, with its soft lines and ergonomic shape, is ideal for moments of relaxation.

IT La sapiente lavorazione dei listelli in legno di teak termo-curvato dona un aspetto sinuoso ed accogliente agli elementi della linea Swing. La chaise-longue dalle linee dolci e dalla forma ergonomica è ideale per momenti di relax.

FR Les lattes de bois en teck thermo-courbé savamment travaillées confèrent un aspect ondulé et accueillant aux éléments de la ligne Swing. La chaise-longue, qui offre des lignes douces et une forme ergonomique, est idéale pour les moments de relaxation.







The chaise-longue, with its soft lines and ergonomic shape, is ideal for moments of relaxation. Swing has a stainless-steel accessory, which supports and raises the structure from the ground, giving it a light, comfortable feel.

IT La chaise-longue dalle linee dolci e dalla forma ergonomica è ideale per momenti di relax. Swing dispone di un accessorio in acciaio inox, che supporta e rialza da terra la struttura, conferendole un'aria leggera e confortevole.

FR La chaise-longue, qui offre des lignes douces et une forme ergonomique, est idéale pour les moments de relaxation. Swing dispose d'un accessoire en acier inoxydable, qui soutient et surélève la structure en lui conférant un style léger et confortable.

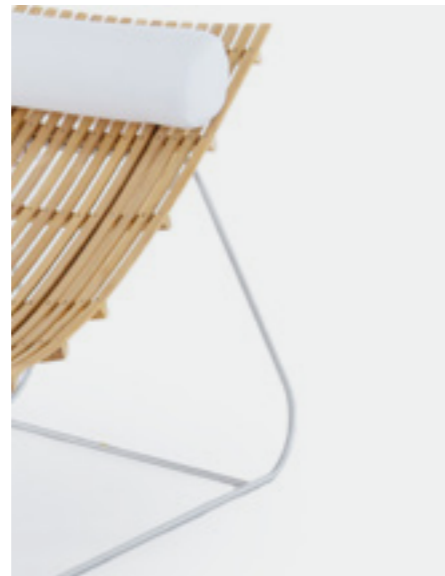



M Swing

- Teak / Teak / Teck
- Stainless steel / Acciaio inox / Acier inoxydable
- Removable cushions / Cuscini sfoderabili / Coussins déhoussables

Sunlounger / Lettino / Bain de soleil



Sunlounger / Lettino / Bain de soleil
SWIDO

Supporto chaise longue / Chaise longue / Support pour chaise longue
SWISUP

CUSWIDO001
Headrest cushion / Cuscino poggiatesta / Coussin d'appui-tête

Stool / Sgabello / Tabouret



Stool / Sgabello / Tabouret
SGANTE

Finishes / Finiture / Finitions



Teak
Teak
Teck



Stainless steel
Acciaio inox
Acier inoxydable



Removable cushions Diamante 001
Cuscini sfoderabili Diamante 001
Coussins déhoussables Diamante 001

Tline

Tradition and innovation come together in Tline, a collection designed by Adam D. Tihany.

The line is characterised by the unmistakable perforated texture, reminiscent of the traditional pattern of the 1950s reinterpreted in a more contemporary version.

IT Tradizione e innovazione confluiscono in Tline, una collezione disegnata da Adam D. Tihany. La linea è contraddistinta dall'inconfondibile texture traforata, che rimanda alla trama tradizionale degli anni '50 reinterpretata in una versione più contemporanea.

FR Tradition et innovation s'allient dans la collection Tline, conçue par Adam D. Tihany. Cette ligne se caractérise par sa texture ajourée inimitable qui rappelle la trame traditionnelle des années 50, réinterprétée dans une version plus contemporaine.

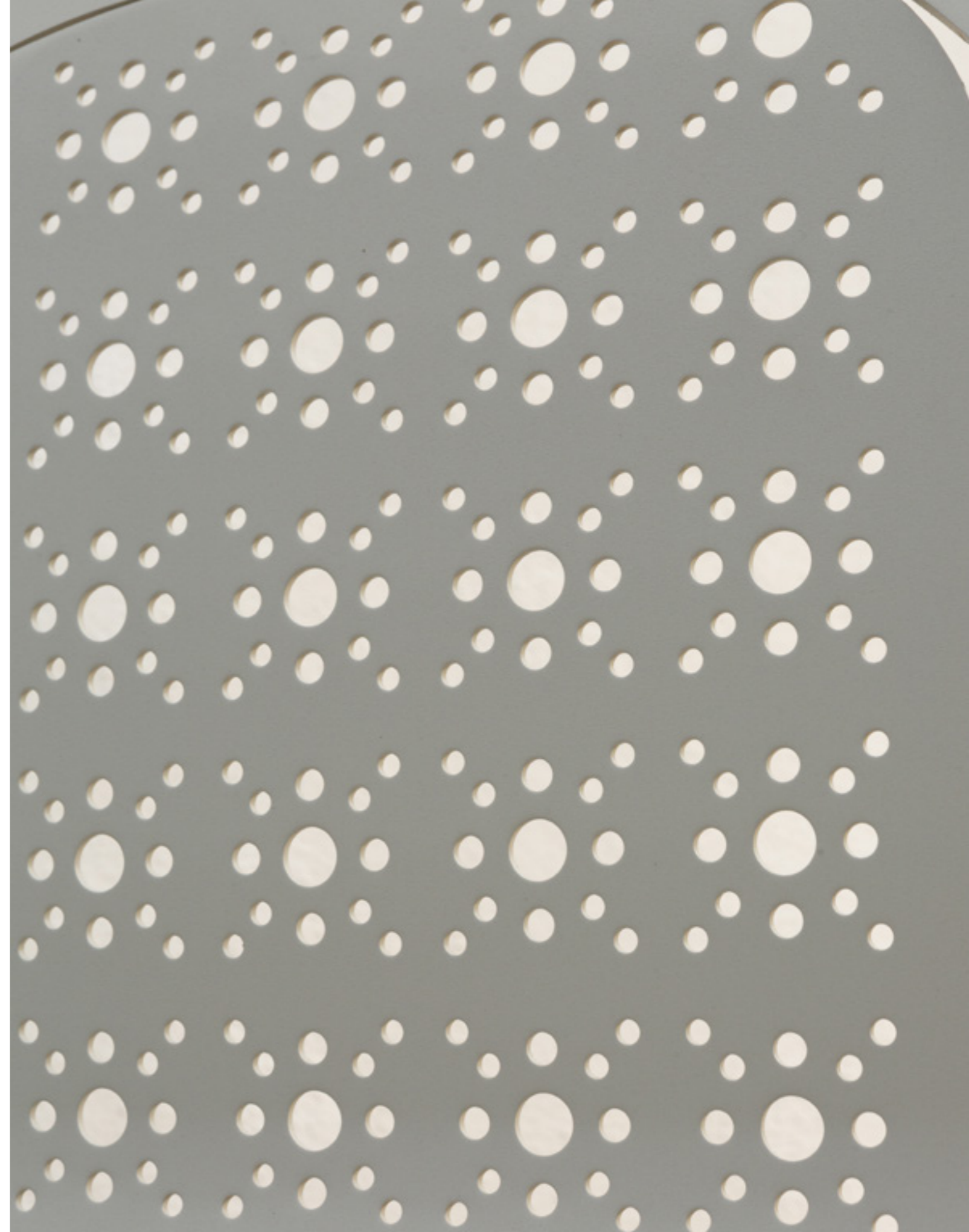





The lightness and efficiency of aluminium is expressed through the alternation of curved, sinuous lines and sharper, more basic geometries, expertly crafted to lend the many elements an air of contemporaneity, practicality and elegance.

IT La leggerezza ed efficienza dell'alluminio si esprime attraverso l'alternanza di linee curve e sinuose a geometrie più nette ed essenziali, sapientemente lavorate per conferire ai molteplici elementi contemporaneità, praticità ed eleganza.

FR La légèreté et la fonctionnalité de l'aluminium s'expriment à travers l'alternance de lignes courbes et sinueuses et de formes géométriques nettes et essentielles, soigneusement travaillées pour conférer un style contemporain, pratique et élégant à de multiples éléments.







The ends of the lounge have the same curved shape as the rest of the collection. The backrest can be reclined to various angles, making it ideal for all needs. The perforated pattern filters the light, casting a pleasant play of shadows onto the ground.

IT Le estremità del lettino seguono la sagoma curvilinea della collezione. Lo schienale è reclinabile in diverse inclinazioni rendendolo ideale per ogni tipo di necessità. Il pattern traforato filtra la luce, proiettando sul terreno un piacevole gioco di ombre.

FR Les extrémités de la chaise longue épousent la forme curviligne de la collection. Le dossier propose différentes inclinaisons, ce qui le rend idéal pour tout type de nécessité. Le motif perforé filtre la lumière, projetant un agréable jeu d'ombres au sol.





The collection is available in the natural shades of mud and dove grey, which are ideal for furnishing outdoor environments with harmony.

IT La collezione è disponibile nelle tonalità naturali del fango e del tortora, ideale per arredare con armonia gli ambienti esterni.

FR La collection est disponible dans une palette de tons naturels taupe et gris tourterelle, idéale pour meubler avec goût les espaces extérieurs.



- Aluminum / Alluminio / Aluminium
- Removable cushions col. standard Diamante 001 / Cuscini sfoderabili col. standard Diamante 001 / Coussins déhoussables col. standard Diamante 001

Sitting / Sedute / Assises

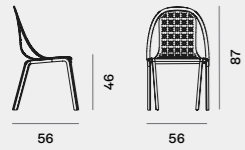

Chair / Sedia / Chaise

TISEFA

Mud / Fango / Taupe

TISETO

Dove grey / Tortora / Gris tourterelle

CUTISE

Cushion / Cuscino / Coussin

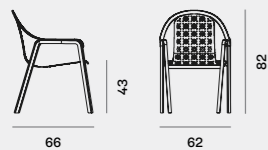

Armchair / Poltrona / Fauteuil

TIPOLFA

Mud / Fango / Taupe

TIPOLTO

Dove grey / Tortora / Gris tourterelle

CUTIPO

Cushion / Cuscino / Coussin

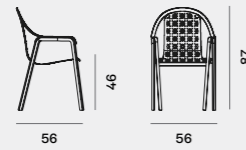

Armchair / Poltroncina / Petit fauteuil

TISEBRFA

Mud / Fango / Taupe

TISEBRTO

Dove grey / Tortora / Gris tourterelle

CUTISE

Cushion / Cuscino / Coussin

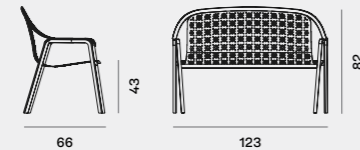

Sofa / Divano / Canapé

TIDI2PFA

Mud / Fango / Taupe

TIDI2PTO

Dove grey / Tortora / Gris tourterelle

CUTIDI2P

Cushion / Cuscino / Coussin

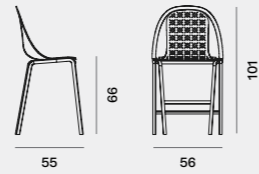

Stool / Sgabello / Tabouret

TISGAFA

Mud / Fango / Taupe

TISGATO

Dove grey / Tortora / Gris tourterelle

CUTISE

Cushion / Cuscino / Coussin

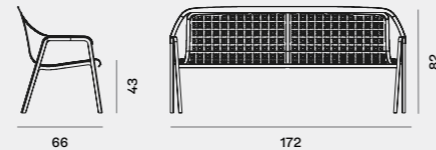

Sofa / Divano / Canapé

TIDI3PFA

Mud / Fango / Taupe

TIDI3PTO

Dove grey / Tortora / Gris tourterelle

CUTIDI3P

Cushion / Cuscino / Coussin

Sunlounger / Lettino / Bain de soleil

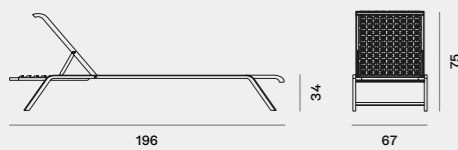

Sunlounger / Lettino / Bain de soleil

TILETFA

Mud / Fango / Taupe

TILETTO

Dove grey / Tortora / Gris tourterelle

CUTILET

Cushion / Cuscino / Coussin

- Aluminum / Alluminio / Aluminium
- Removable cushions col. standard Diamante 001 / Cuscini sfoderabili col. standard Diamante 001 / Coussins déhoussables col. standard Diamante 001

Tables / Tavoli / Tables

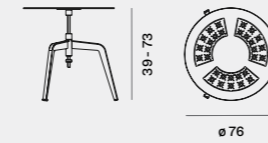

Adjustable round table / Tavolo rotondo regolabile / Table réglable ronde

TITA70FA

Mud / Fango / Taupe

TITA70TO

Dove grey / Tortora / Gris tourterelle

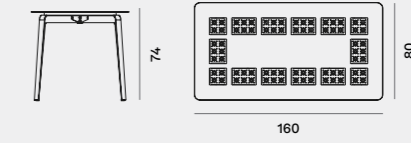

Rectangular table / Tavolo rettangolare / Table rectangulaire

TITAREFA

Mud / Fango / Taupe

TITARETO

Dove grey / Tortora / Gris tourterelle

Finishes / Finiture / Finitions

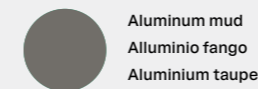

Aluminum mud
Alluminio fango
Aluminium taupe



Removable cushions Masterline Colour Collection pg. 458
Cuscini sfoderabili Masterline Colour Collection pg. 458
Coussins déhoussables Masterline Collection Couleur pg. 458



Aluminum dove grey
Alluminio tortora
Aluminium gris tourterelle

Colours made to order / Colori su richiesta / Couleurs sur demande



Aluminum graphite
Alluminio grafite
Aluminium graphite



Aluminum white
Alluminio bianco
Aluminium blanc

Tuscany represents a classic icon of handcrafted production in powder coated galvanised iron. The attention to detail paid by the hands of expert craftsmen translates into a structure with thin, geometric shapes, which characterise every element of the line.

IT Toscana rappresenta un'icona classica della produzione artigianale in ferro zincato verniciato a polveri. L'attenzione al dettaglio curato dalle mani di esperti artigiani si traduce in una struttura dai volumi sottili e geometrici, che caratterizzano tutti gli elementi della linea.

FR Toscana représente une icône classique de la production artisanale en fer galvanisé revêtu de poudre. Tous les éléments de cette ligne se caractérisent par l'attention au détail apportée par des maîtres artisans et offrent des structures aux volumes fins et géométriques.







The sofas are completed with upholstered items that are embellished by sophisticated topstitching that combines aesthetics and comfort in a product of timeless elegance.

IT I divani si completano con gli imbottiti impreziositi da raffinate impunture che uniscono estetica e comfort in un prodotto dall'eleganza senza tempo.

FR Les canapés sont ornés de parties matelassées ornées de surpiqûres raffinées qui allient esthétique et confort dans des produits à l'élégance intemporelle.



The ends of the armrests of the folding armchair are curled, giving it a classic, romantic look.

IT L'estremità del bracciolo della poltroncina pieghevole termina in un motivo a ricciolo, donandole un aspetto classico e romantico.

FR L'extrémité de l'accoudoir de la chaise pliante se termine par un motif de tourbillon, ce qui lui donne un look classique et romantique.





The galvanised iron frame of the tables, which is slender and light, can be customised with tops in various shapes and sizes. The round table features a hole in the centre, while the rectangular version is extendable up to a size of 300 cm.

IT La struttura dei tavoli in ferro zincato, slanciata e leggera, si personalizza con piani di diverse forme e dimensioni. Il tavolo rotondo è caratterizzato da un foro centrale, mentre la versione rettangolare è allungabile sino ad una dimensione di 300 cm.

FR La structure des tables en fer galvanisé, élancée et légère, est personnalisée avec des plateaux de différentes formes et tailles. La table ronde se caractérise par un trou central, tandis que la version rectangulaire est extensible jusqu'à une taille de 300 cm.



- Powder coated galvanized iron / Ferro zincato verniciato a polveri / Fer galvanisé enduit de poudre
- Removable cushions col. standard Latte 04 / Cuscini sfoderabili col. standard Latte 04 / Coussins déhoussables col. standard Latte 04

Sitting / Sedute / Assises

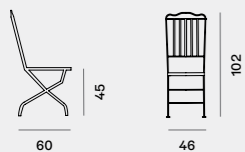

Chair / Sedia / Chaise
CASEG

CUCAPSA
Cushion / Cuscino / Coussin

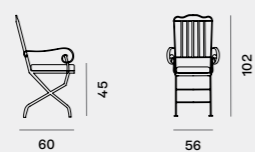

Small armchair / Poltroncina / Petit fauteuil
CAPOG

CUCAPSA
Cushion / Cuscino / Coussin

Lounge / Lounge / Lounge

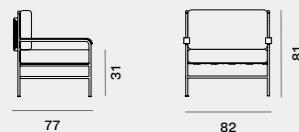

Armchair / Poltrona / Fauteuil
TOPO

TOPOCU
Cushion / Cuscino / Coussin

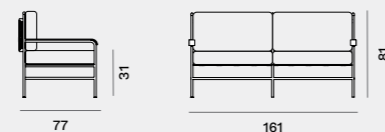

Sofa / Divano / Canapé
TODI

TODICU
Cushion / Cuscino / Coussin

Tables / Tavoli / Tables

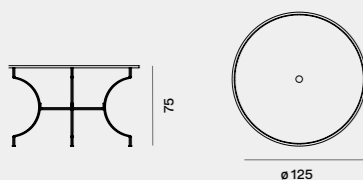

Round table / Tavolo rotondo / Table ronde
PAROG

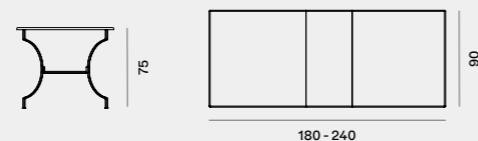

Rectangular extendable table / Tavolo allungabile rettangolare / Table extensible rectangulaire
ARTAV

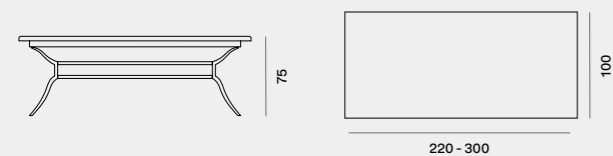

Rectangular extendable table / Tavolo allungabile rettangolare / Table extensible rectangulaire
AVTAV

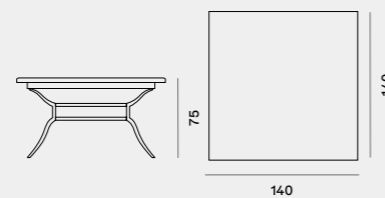

Square table / Tavolo quadrato / Table carré
AVTAVQ

- Powder coated galvanized iron / Ferro zincato verniciato a polveri / Fer galvanisé enduit de poudre
- Removable cushions col. standard Latte 04 / Cuscini sfoderabili col. standard Latte 04 / Coussins déhoussables col. standard Latte 04



Rectangular coffee table / Tavolino rettangolare / Table basse rectangulaire
TORE76

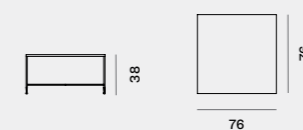

Rectangular coffee table / Tavolino rettangolare / Table basse rectangulaire
TOQU76



Rectangular coffee table / Tavolino rettangolare / Table basse rectangulaire
TORE38

Finishes / Finiture / Finitions

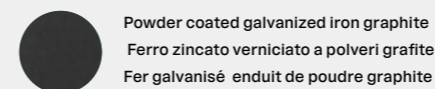

Powder coated galvanized iron graphite
Ferro zincato verniciato a polveri grafite
Fer galvanisé enduit de poudre graphite



Removable cushions Masterline Colour Collection pg. 458
Cuscini sfoderabili Masterline Colour Collection pg. 458
Coussins déhoussables Masterline Colour Collection pg. 458

M Welcome

The solidity of teak softened by the handcrafted interweaving of rope are the characteristics of the Welcome line, an elegant collection timeless in style.

The modularity of the furnishings makes it possible to configure areas of relaxation and conviviality according to needs and in harmony with the outdoor space.

IT La solidità del teak addolcita dall'intreccio artigianale della corda sono le caratteristiche della linea Welcome, collezione elegante e stile senza tempo.

La modularità degli arredi permette di configurare zone di relax e convivialità in linea con le proprie esigenze e in armonia con lo spazio esterno.

FR La robustesse du teck adoucie par le tressage artisanal de la corde tressée artisanalement caractérise la ligne Welcome, une collection élégante et au style intemporel. La modularité des meubles permet d'aménager des zones de détente et de convivialité en accord avec ses propres besoins et en harmonie avec l'espace extérieur.







The line mainly consists of generously proportioned teak sofas mounted on aluminium legs, a detail that adds finesse and personality.

IT La linea si compone principalmente di divani in teak dalle proporzioni generose montati su piedini in alluminio, dettaglio che aggiunge preziosità e personalità.

FR Cette ligne se compose principalement de canapés en teck aux dimensions généreuses montés sur pieds en aluminium, un détail qui ajoute une touche de raffinement et de caractère.







The teak frames can be embellished by a hand-woven polyolefin rope weave in a mélange beige tone, capable of infusing warmth and comfort and recreating a pleasant and harmonious outdoor space.

IT Le strutture in teak possono essere arricchite da un intreccio in corda poliolefinica intrecciata a mano dalla tonalità beige mélange, capace di infondere calore e comfort e ricreare uno spazio outdoor piacevole ed armonioso.

FR Les structures en teck peuvent être enrichies d'un tissage de corde de polyoléfine tissée à la main dans un ton beige mélangé, capable d'infuser chaleur et confort et de recréer un espace extérieur agréable et harmonieux.





The line is completed with two low coffee tables in different sizes: square 55x55 cm and rectangular 139x83 cm. Both echo the teak slatted pattern of the collection, standing on bronze-coloured aluminium feet.

IT La linea si completa di due tavolini bassi di diverse dimensioni: quadrato 55x55 cm e rettangolare 139x83 cm. Entrambi riprendono il pattern a doghe in teak della collezione, sorretti da piedini in alluminio color bronzo.

FR La ligne est complétée par deux tables basses de différentes tailles : carrée 55x55 cm et rectangulaire 139x83 cm. Les deux font écho au motif à lattes en teck de la collection, soutenu par des pieds en aluminium couleur bronze.



- Teak / Teak / Teck
- Aluminum / Alluminio / Aluminium
- Polyolefin cord / Corda poliolefinica / Corde en polyoléfine
- Removable cushions col. standard Diamante 001 / Cuscini sfoderabili col. standard Diamante 001 / Coussins déhoussables col. standard Diamante 001

Lounge / Lounge / Lounge



Armchair / Poltrona / Fauteuil

WELPO
Structure teak / Struttura teak / Structure en teck

WELCPO
Structure teak and cord / Struttura teak e corda / Structure en teck et corde

WELCUPO
Seat cushion / Cuscino seduta / Coussin de assise

WELCU70SC
Backrest cushion / Cuscino schienale / Coussin de dos



Pouf / Pouf / Pouf

WELPU
Structure teak / Struttura teak / Structure en teck

WELCUPU
Cushion / Cuscino / Coussin

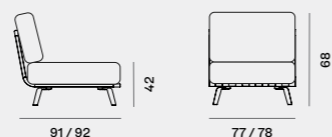

Backrest module / Modulo spalla / Module dossier

WELSPA
Structure teak / Struttura teak / Structure en teck

WELCUSP
Seat cushion / Cuscino seduta / Coussin de assise

WELCSPA
Structure teak and cord / Struttura teak e corda / Structure en teck et corde

WELCUPU
Seat cushion / Cuscino seduta / Coussin de assise

WELCU80SC
Backrest cushion / Cuscino schienale / Coussin de dos

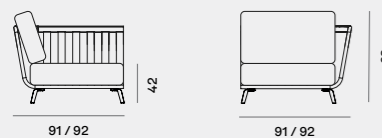

Lt module / Modulo sx / Module g

WELANS90
Structure teak / Struttura teak / Structure en teck

WELCANS90
Structure teak and cord / Struttura teak e corda / Structure en teck et corde

WEL90CUS
Seat cushion / Cuscino seduta / Coussin de assise

WELCU80SC
Backrest cushion / Cuscino schienale / Coussin de dos

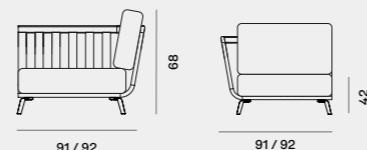

Rt Module / Modulo dx / Module d

WELAND90
Structure teak / Struttura teak / Structure en teck

WELCAND90
Structure teak and cord / Struttura teak e corda / Structure en teck et corde

WEL90CUD
Seat cushion / Cuscino seduta / Coussin de assise

WELCU80SC
Backrest cushion / Cuscino schienale / Coussin de dos

- Teak / Teak / Teck
- Aluminum / Alluminio / Aluminium
- Polyolefin cord / Corda poliolefinica / Corde en polyoléfine
- Removable cushions col. standard Diamante 001 / Cuscini sfoderabili col. standard Diamante 001 / Coussins déhoussables col. standard Diamante 001

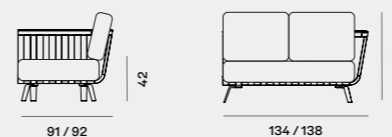

Lt module / Modulo sx / Module g

WELANS130
Structure teak / Struttura teak / Structure en teck

WELCANS130
Structure teak and cord / Struttura teak e corda / Structure en teck et corde

WEL130CUD
Seat cushion / Cuscino seduta / Coussin de assise

WEL130CUS
Backrest cushion / Cuscino schienale / Coussin de dos

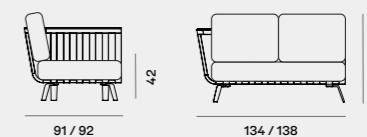

Rt Module / Modulo dx / Module d

WELAND130
Structure teak / Struttura teak / Structure en teck

WELCAND130
Structure teak and cord / Struttura teak e corda / Structure en teck et corde

WEL130CUD
Seat cushion / Cuscino seduta / Coussin de assise

WEL130CUS
Backrest cushion / Cuscino schienale / Coussin de dos

Coffee tables / Tavolini / Table basse

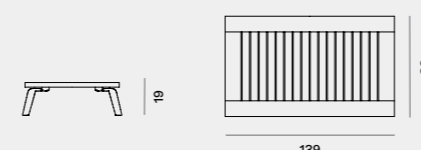

Rectangular coffee table / Tavolino rettangolare / Table basse rectangulaire
WELTABR

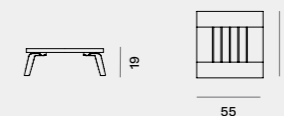

Square coffee table / Tavolino quadrato / Table basse carrée
WELTABQ

Finishes / Finiture / Finitions

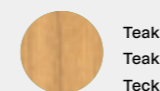

Teak
Teak
Teck



Polyolefin cord beige mélange
Corda poliolefinica beige mélange
Corde en polyoléfine beige mélange



Aluminum bronze
Alluminio bronzo
Aluminium bronze



Removable cushions Masterline Colour Collection pg. 458
Cuscini sfoderabili Masterline Colour Collection pg. 458
Coussins déhoussables Masterline Colour Collection pg. 458

Sunshades

Covercar

Dafne

Lipari

Manta

Nagi

Orangerie

Shibuya®

Solaire

Salento

Tibisco

Covercar

The coverings made specially for cars are handcrafted from impregnated Nordic pine in bankirai color, a wood capable of withstanding all atmospheric agents and temperatures.

IT Le coperture dedicate alle auto sono realizzate artigianalmente in pino nordico impregnato color bankirai, un legno resistente a tutti gli agenti atmosferici e temperature.

FR Les abris-autos de fabrication artisanale sont composés de pin nordique imprégné de couleur bankirai, un bois résistant à tous les agents atmosphériques, quelles que soient les températures.







Covercar

- Nordic pine / Pino nordico / Pin nordique
- Green canadian tiles / Tegole canadesi verdi / Tuiles canadienne de couleur verte

Covercar Single / Covercar Singolo / Covercar Single

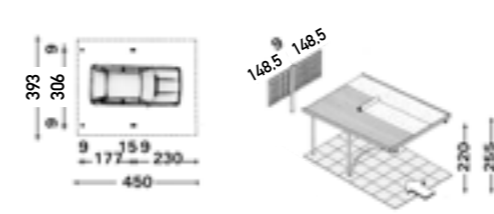

W 393 D 450 H 255

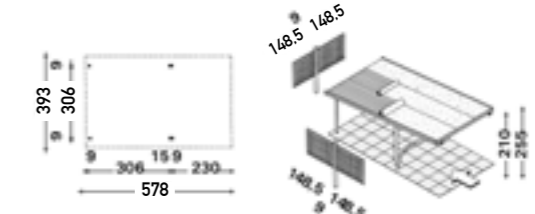

W 393 D 578 H 255

Covercar Double / Covercar Doppio / Covercar Double

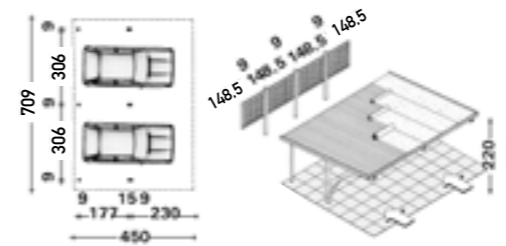

W 709 D 450 H 255

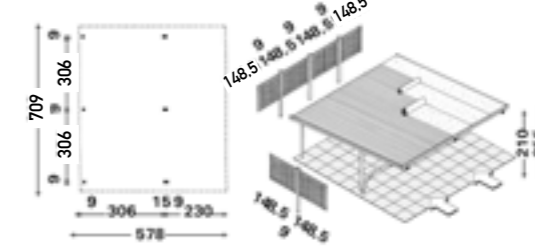

W 709 D 578 H 255

Covercar / Covercar / Covercar

W 393 D 450 H 255 COS45G

W 393 D 578 H 255 COS60G

Double covercar / Covercar doppio / Covercar double

W 709 D 450 H 255 COD45G

W 709 D 578 H 255 COD60G

Single extension to widen COD45G
Estensione singola per estendere in larghezza il COD45G
Extension simple pour agrandir en largeur un covercar COD45G

W 318 D 450 H 255 COD45GEX

Single extension to widen COD60G
Estensione singola per estendere in larghezza il COD60G
Extension simple pour agrandir en largeur un covercar COD60G

W 318 D 578 H 255 COD60GEX

Fixing kit excluded / Kit di fissaggio escluso / kit de fixation exclu

Square pattern / Grigliati a maglia quadrata / Treillages maille carrée



148,5 X 177

GR34

177 X 177

GR44

Finishes / Finiture / Finitions



Nordic pine bankirai colour
Pino nordico color bankirai
Pin nordique bankirai couleur

Dafne

Its perimeter decoration made from graphite-coloured powder-coated galvanised iron makes the traditionally styled Dafne projecting roof stand out. Extensions make it possible to configure the best solution for every need. The embossed polycarbonate covering is an excellent solution for sheltering from bad weather.

IT La pensilina Dafne dal sapore tradizionale, si distingue per il decoro perimetrale realizzato in ferro zincato verniciato a polveri color grafite. Le estensioni permettono di configurare a piacere la soluzione migliore in base ad ogni esigenza. La copertura in polycarbonato goffrato è un'ottima soluzione per riparare dalle intemperie.

FR Le auvent Dafne de style traditionnel se distingue par le design soigné de sa décoration latérale, réalisée en fer galvanisé peint revêtu de poudre de couleur graphite. Les extensions permettent d'obtenir la configuration la mieux adaptée en fonction des besoins. La couverture en polycarbonate gaufré offre une solution parfaite pour protéger des intempéries.



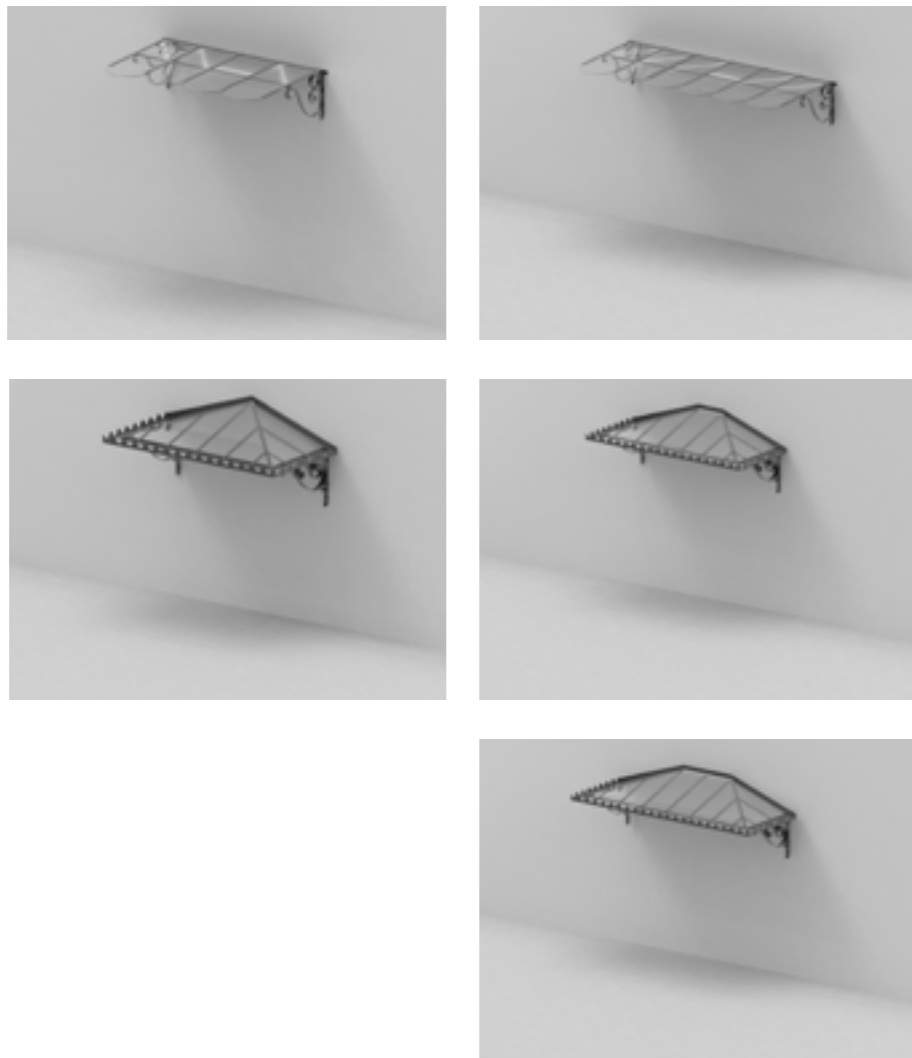

The canopy boasts different shapes and sizes: a flat one with rounded ends measuring 217x60 cm or 317x60 cm with the option of extending up to 201 or 301 cm; and a more geometric and square-shaped one with a length of 240, 280 or 320 cm and a height of 104 cm.

IT La pensilina vanta diverse forme e dimensioni: una piatta con estremità arrotondate di 217x60 cm o 317x60 cm con possibilità di estensione fino a 201 o 301 cm; e una più geometrica e squadrata dalla lunghezza di 240, 280 o 320 cm e altezza di 104 cm.

FR L'auvent se décline en différentes formes et dimensions : un plat aux extrémités arrondies mesurant 217x60 cm ou 317x60 cm avec possibilité d'extension jusqu'à 201 ou 301 cm ; et un plus géométrique et carré avec une longueur de 240, 280 ou 320 cm et une hauteur de 104 cm.

Dafne

- Iron graphite / Ferro grafite / Fer couleur graphite
- Polycarbonate embossed / Policarbonato goffrato / Polycarbonate gaufré

Awning / Pensilina / Auvent

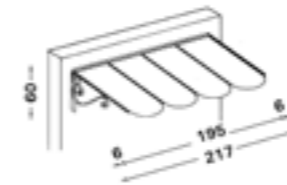

W 217 D 120 H 60

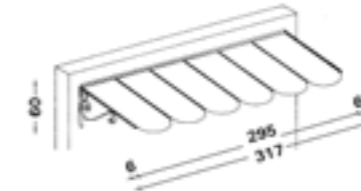

W 317 D 120 H 60

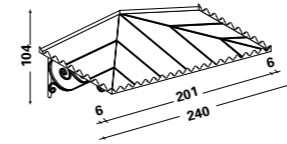

W 240 D 120 H 104

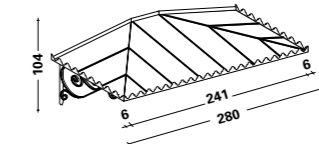

W 280 D 120 H 104

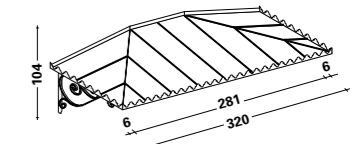

W 320 D 120 H 104

Awning	W 217 D 120 H 60	PEF200
	W 317 D 120 H 60	PEF300
Extension for PEF200 - PEF300 Estensione per PEF200 - PEF300 Extension pour PEF200 - PEF300	W 201 D 120 H 60	PEF200EX
	W 301 D 120 H 60	PEF300EX
Aawning	W 240 D 120 H 104	PES240
	W 280 D 120 H 104	PES280
	W 320 D 120 H 104	PES320

Fixing kit excluded / Kit di fissaggio escluso / kit de excluded

Finishes / Finiture / Finitions

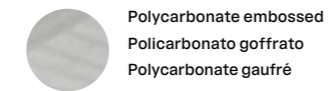
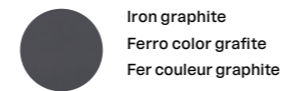

The Lipari parasol collection is designed to complete and customise outdoor spaces by combining practicality, functionality and aesthetics. Available in various sizes and finishes, the line allows the utmost freedom to create and choose the best solution based on your needs.

IT La collezione di ombrelloni Lipari è pensata per completare e personalizzare gli spazi esterni combinando praticità, funzionalità ed estetica. Disponibile in molteplici dimensioni e finiture la linea lascia la massima libertà di comporre e scegliere la soluzione migliore in base alle proprie esigenze.

FR La collection de parasols Lipari est conçue pour compléter et personnaliser les espaces extérieurs et se distingue par son aspect pratique, fonctionnel et esthétique. Les produits de cette ligne sont proposés dans de multiples dimensions et finitions, permettant ainsi d'obtenir la meilleure configuration possible en fonction des exigences.

The 100% acrylic fabric covering, available in various colours, is water-repellent and resistant to salt, stains and fading caused by U.V. rays.

IT I telo in tessuto 100% acrilico, disponibile in diverse colorazioni, è idrorepellente e resistente a salsedine, macchie e sbiadimento dovuto all'azione dei raggi U.V.

FR La toile en tissu 100% acrylique, proposée en divers coloris, est hydrofuge, résistante au sel, aux taches et à la décoloration due à l'action des rayons U.V.







The materials range from ash wood to the central pole made from beech, the base made from stone, stainless-steel or galvanized iron, right up to a circular base made from concrete and an adjustable iroko wood shelf, designed by Studio Adolini.

IT I materiali variano dal legno di frassino al faggio del palo centrale, alla base in pietra, acciaio inox o ferro zincato fino ad una base circolare con struttura in cemento e ripiano in legno di iroko regolabile, disegnata dallo Studio Adolini.

FR Les matériaux utilisés sont très variés. On peut y trouver un mât central en bois de hêtre ou de frêne, un socle en pierre, en acier inoxydable ou en fer galvanisé, et une base circulaire en béton dotée d'une étagère en bois d'iroko réglable, conçue par Studio Adolini.

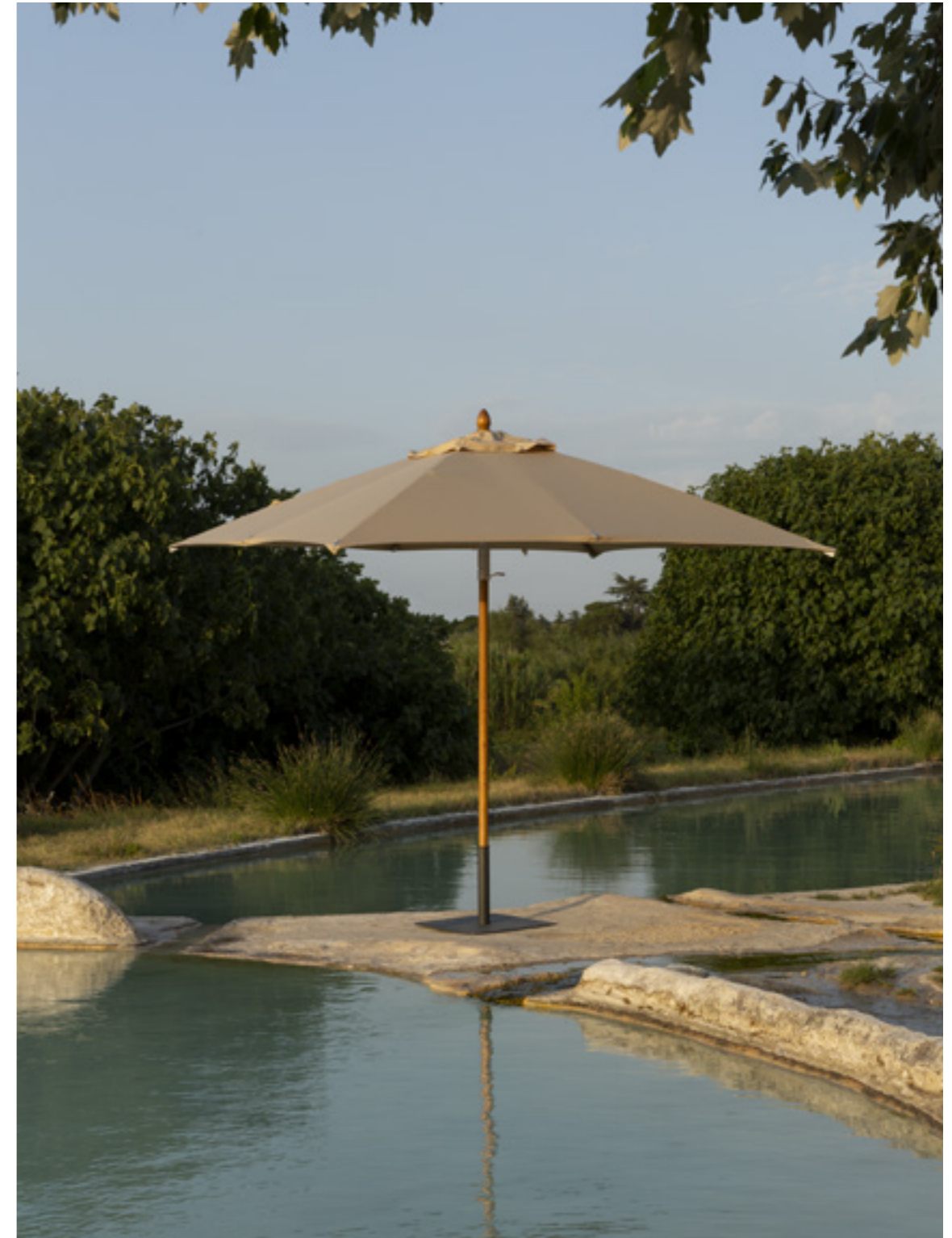

- Solid wood / Legno massello / Bois massif
- Aluminum / Alluminio / Aluminium
- Cement / Cemento / Béton
- Iroko / Iroko / Iroko
- Acrylic 100% / Acrilico 100% / 100% Acrylique

Rectangular umbrellas / Ombrelloni rettangolari / Parasols rectangulaires

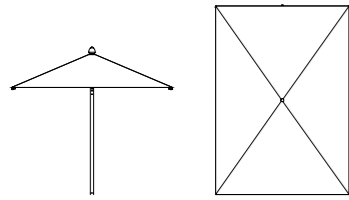

Ø 6 / 250 x 350 H 277 - 300 x 400 H 295

Wood shafts Ø 6 / palo in legno Ø 6 / mât en bois Ø 6	250 x 350 H 277	300 x 400 H 295
Off white / Bianco grezzo / Blanc écreu	RE95A	RE34A
Coffee / Caffè / Café	RE95MA	RE34MA
Cord / corda / corde	RE95CA	RE34CA
Rust / ruggine / rouille	RE95RUA	RE34RUA
Dove grey / tortora / tourterelle	RE95TOA	RE34TOA

Aluminium shafts Ø 4 / palo in alluminio Ø 4 / mât en aluminium Ø 4		300 x 200 - H 264
Off white / Bianco grezzo / Blanc écreu		OMSUREB
Cord / corda / Corde		OMSUREC

Square Umbrellas / Ombrelloni quadrati / Parasols carrés

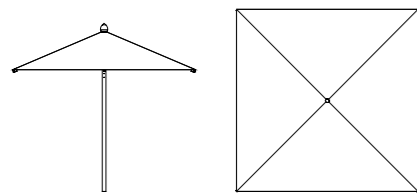

Ø 6 / 300 x 300 H 277 - 400 x 400 H 322

Wood shafts Ø 6 / palo in legno Ø 6 / mât en bois Ø 6	300 x 300 H 277	400 x 400 H 322
Off white / bianco grezzo / blanc écreu	QU98A	QU4A
Coffee / café / café	QU98MA	QU4MA
Cord / corda / corde	QU98CA	QU4CA
Rust / ruggine / rouille	QU98RUA	QU4RUA
Dove grey / tortora / tourterelle	QU98TOA	QU4TOA

- Solid wood / Legno massello / Bois massif
- Aluminum / Alluminio / Aluminium
- Cement / Cemento / Béton
- Iroko / Iroko / Iroko
- Acrylic 100% / Acrilico 100% / 100% Acrylique

Round umbrellas / Ombrelloni rotondi / Parasols ronds

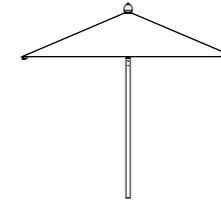

Ø 6 / Ø 350 H 277 - Ø 400 H 295

Wood shafts Ø 6 / palo in legno Ø 6 / mât en bois Ø 6	Ø 350 H 277	Ø 400 H 295
Off white / Bianco grezzo / Blanc écreu	RO92A	RO4A
Coffee / Caffè / Café	RO92MA	RO4MA
Cord / corda / Corde	RO92CA	RO4CA
Rust / Ruggine / Rouille	RO92RUA	RO4RUA
Dove grey / Tortora / Tourterelle	RO92TOA	RO4TOA

Aluminium shafts Ø 4 / palo in alluminio Ø 4 / mât en aluminium Ø 4		Ø 200 H 254
Off white / Bianco grezzo / Blanc écreu		OMSUROB
Cord / Corda / Corde		OMSUROC

Concrete base / Base in cemento / Base en béton



Concrete base with adjustable iroko top with hole for umbrella (pole Ø 4)
Base in cemento con piano regolabile in iroko con foro per ombrellone (palo Ø 4)
Base en béton et plateau réglable en iroko avec trou pour parasol (mât Ø 4)

base Ø 45 top Ø 55 H 53 max.
base Ø 45 piano Ø 55 H 53 max.
base Ø 45 plateau Ø 55 H 53 max.

BAOMCEP







Concrete base with adjustable iroko top with hole for umbrella (pole Ø 5 - 6)
Base in cemento con piano regolabile in iroko con foro per ombrellone (palo Ø 5 - 6)
Base en béton et plateau réglable en iroko avec trou pour parasol (mât Ø 5 - 6)

base Ø 70 top Ø 85 H 74 max.
base Ø 70 piano Ø 85 H 74 max.
base Ø 70 plateau Ø 85 H 74 max.

BAOMCEG

- Solid wood / Legno massello / Bois massif
- Aluminum / Alluminio / Aluminium
- Cement / Cemento / Béton
- Iroko / Iroko / Iroko
- Acrylic 100% / Acrilico100% / 100% Acrylique

Accessories / Accessori / Accessoires

	Base plate 62 x 62 for umbrellas powder coated galvanized iron Piastra di base 62 x 62 bianca per ombrelloni ferro zincato verniciato a polveri Socle blanc 62 x 62 pour parasol fer galvanisé enduit de poudre	White / Bianco / Blanc	PI62B
		Graphite / Grafite / Graphite	PI62G
	Single umbrella sleeve in white Canotto bianco singolo per ombrellone Adaptateur blanc simple pour parasol	White / Bianco / Blanc	PI62BCAN
		Graphite / Grafite / Graphite	PI62GCAN
	Ballast for white umbrella base (15kg) Zavorra per base ombrellone bianca (Kg. 15) Contrepoids pour base parasol blanche (Kg. 15)	White / Bianco / Blanc	PI62BZAV
		Graphite / Grafite / Graphite	PI62GZAV
	Kit of four feet in black for umbrellas base Kit 4 piedini colore nero per base ombrellone Kit de 4 petits pieds couleur noir pour base parasol		PIE4PI62
	Base plate Serena 40 x 40 35 kg with sleeve (to accomodate shafts max Ø 4) in galvanized iron - for OMSUREB / OMSUREC Base di pietra Serena 40 x 40 kg 35 con canotto (predisposto per accogliere steli Ø max. 4) di ferro zincato - per OMSUREB / OMSUREC Socle en pierre Serena 40 x 40 kg 35 avec bague (prévue pour accueillir des mâts Ø max. 4) en fer galvanisé - pur OMSUREB / OMSUREC		BASUN
	Light L 72 for outdoor use (suitable for umbrella shafts and posts in general, max Ø 70 mm) with three light sources and white acrylic globes. Simple fitting and closing system ensures easy removal; specified for incandescent bulbs (max 40 W) or energy saving DULUX EL (max. 20W) L 72 per esterni (adatta per steli di ombrelloni e pali in genere, max Ø mm 70) a tre luci con diffusori a globo di acrilico bianco. Il sistema di aggancio e chiusura la rende facilmente rimovibile; può ospitare sia lampadine ad incandescenza (max 40W) che a risparmio energetico DULUX EL (max 20W) L 72 d'extérieur (pour mâts de parasols et autres supports max Ø 70 mm) à trois ampoules avec diffuseur globe en acrylique blanc. Le système d'accrochage et de verrouillage en facilite la manipulation ; fonctionne avec des ampoules à incandescence (max 40W) ou des ampoules à économie d'énergie DULUX EL (max 20W).		LAOM3
	Waterproof cover dark green in 50% polyester and 50% PVC, for Umbrellas Ref. QU98 - RO92 - RO4 Copertura impermeabile verde scuro di poliestere 50% e PVC 50% per ombrelloni Art. QU98 - RO92 - RO4 Housse imperméable vert foncé en 50% polyester et 50% PVC pour parasol Réf. QU98 - RO92 - RO4		CO1
	Waterproof cover dark green in 50% polyester and 50% PVC, for Umbrellas Ref. RE95 - QU4 - RE34 Copertura impermeabile verde scuro di poliestere 50% e PVC 50% per ombrelloni Art. RE95 - QU4 - RE34 Housse imperméable vert foncé en 50% polyester et 50% PVC pour parasol Réf. RE95 - QU4 - RE34		CO2









The umbrellas can be completely disassembled. It is possible to substitute any element including the shade without changing the entire structure, as is the case with most umbrella brands.

Gli ombrelloni sono completamente smontabili. È possibile sostituire ogni elemento, compreso il telo, evitando di cambiare l'intera struttura, come avviene per gran parte degli ombrelloni in commercio.

Les parasols sont complètement démontables. Il est possible de remplacer chaque élément, toile comprise, évitant de remplacer l'entière structure comme pour la plupart des parasols en vente dans le commerce.

- Solid wood / Legno massello / Bois massif
- Aluminum / Alluminio / Aluminium
- Cement / Cemento / Béton
- Iroko / Iroko / Iroko
- Acrylic 100% / Acrilico 100% / 100% Acrylique

Finishes / Finiture / Finitions

	Aluminium graphite Alluminio grafite Aluminium graphite		Concrete Cemento Béton		Solid wood Legno massello Bois massif
	Iroko Iroko Iroko				
	100% acrylic off white 100% bianco grezzo 100% acrylique blanc		100% acrylic cord 100% bianco corda 100% acrylique corde		100% acrylic coffee 100% bianco caffè 100% acrylique café
	100% acrylic dove grey 100% acrilico tortora 100% acrylique gris torturelle		100% acrylic rust 100% bianco ruggine 100% acrylique rouille		

Manta

Manta is a veil with an architectural connotation, designed to generate shaded spaces with practicality and simplicity.

IT Manta è una vela dalla connotazione architettonica, pensata per generare spazi d'ombra con praticità ed essenzialità.

FR Manta est une voile à connotation architecturale conçue pour créer des espaces ombragés de manière très pratique et simple.





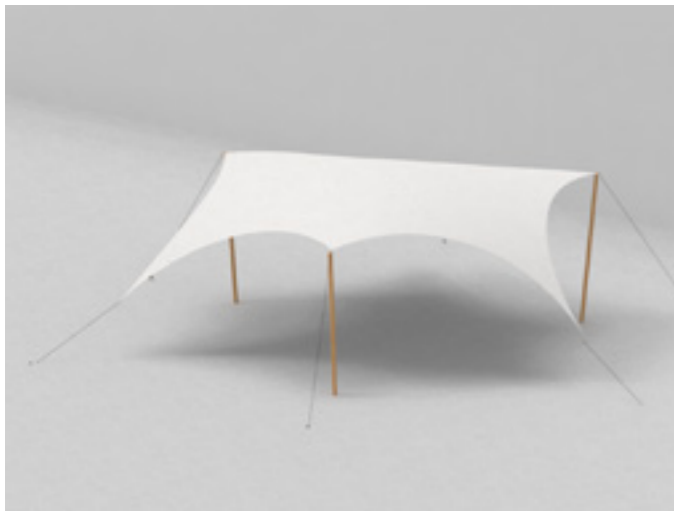

Its structure of Nordic pine in bankitray colour combined with PVC coated fabric for the hexagonal shape and acrylic for the rhomboid shape is certified to withstand winds with an intensity of up to 50/Km per hour.

IT La sua struttura composta da pino nordico color bankitray combinato al tessuto spalmato di PVC per la forma esagonale, e acrilico per la forma romboidale è certificata per la resistenza a venti di intensità sino a 50/Km orari.

FR Sa structure, composée de pin nordique de couleur bankitray, se combine à du tissu enduit de PVC pour la forme hexagonale et acrylique pour la forme en losange, et elle garantit une résistance à des vents d'une intensité allant jusqu'à 50 km/ heure.

Manta

- Treated pine wood / Legno di pino impregnato / Bois de pin traité
- Plastic fabric for outdoor use white / Tessuto plastico per esterni bianco / Tissu plastique pour extérieurs blanc
- Acrylic fabric white / Tessuto acrilico bianco / Tissu 100% acrylique blanc

Hexagonal / Esagonale / Hexagonal

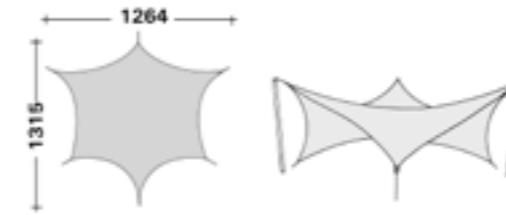

W 1264 D 1315

Rhomboidal / Romboidale / Voile losange



W 400 D 400 - W 500 D 500 - W 565 D 565

Plastic fabric for outdoor use in white / Tessuto plastico per esterni bianco / Tissu plastique pour extérieurs de couleur blanche

Sail hexagonal including ropes, guy ropes, tension pegs and 3 lamellar wooden posts 9 x 9 H 400
 Vela esagonale completa di cime, tiranti, picchetti tendicavo e 3 pali di legno lamellare 9 x 9 H 400
 Voile hexagonale avec cordes, tirants, piquets tendeurs et 3 piliers en bois lamellé-collé 9 x 9 H 400

W 1264 D 1315 MANTA

Acrylic fabric in white / Tessuto acrilico bianco / Tissu 100% acrylique de couleur blanche

W 400 D 400 VEL4L

Sail rhomboidal including ropes, guy ropes, tension pegs and 2 wooden posts Ø 6,8 H 300
 Vela romboidale completa di cime, picchetti, tendicorda e 2 pali di legno Ø 6,8 H 300
 Voile losange avec cordes, piquets, tendeurs et 2 piliers en bois Ø 6,8 H 300

W 500 D 500 VEL5L

W 565 D 565 VEL6L

Finishes / Finiture / Finitions



Treated pine wood
 Legno di pino impregnato
 Bois de pin traité



Plastic fabric white
 Tessuto plastico bianco
 Tissu plastique blanc



Acrylic fabric white
 Tessuto acrilico bianco
 Tissu acrylique blanc

M Nagi

Nagi is a complete system of outdoor structures that can be customised with the utmost freedom, made of impregnated Nordic pine wood in bankirai colour to ensure solidity and durability. Inspired by Japanese aesthetics, the modern circular section profiles instil a sense of airiness and the grids with their geometric striped, diagonal or perpendicular patterns create a balanced play of light and shadow, of full and empty spaces, lending it a sophisticated, contemporary feel.

IT Nagi è un sistema completo di strutture per l'outdoor da personalizzare con massima libertà, realizzato in legno di pino nordico impregnato color bankirai per garantire solidità e durevolezza. Ispirato all'estetica giapponese, i profili moderni a sezione circolare infondono un senso di grande leggerezza e i grigliati dai motivi geometrici a righe, diagonali o perpendicolari creano un equilibrato gioco di luci e ombre, pieni e vuoti, donando un'aria raffinata e contemporanea.

FR Nagi est un système complet de structures pour extérieur à personnaliser en toute liberté, réalisé en pin nordique de couleur bankirai imprégné qui assure solidité et durabilité. Inspiré de l'esthétique japonaise, les profils modernes à section circulaire apportent une impression de grande légèreté. Les treillis aux motifs géométriques à rayures, diagonaux ou perpendiculaires créent un jeu d'ombre et de lumière, de pleins et de vides, et confèrent un style raffiné et contemporain.







WALL-MOUNTED



The structure offers the utmost compositional freedom, allowing the creation of tailor-made solutions, both wall-mounted and free-standing, according to the various needs. Its versatility is also expressed from an aesthetic point of view, thanks to the various finishes available for the coverings: bamboo mats, sliding acrylic fabric sheets and wooden slats onto which a LED lighting system can be added.

IT La struttura offre la massima libertà compositiva, dando la possibilità di creare soluzioni su misura, adossate o autoportanti, in base alle diverse esigenze. La sua versatilità si esprime anche dal punto di vista estetico, grazie alle diverse finiture disponibili per le coperture: stuoie in bambù, teli scorrevoli in tessuto acrilico e listelli in legno sui quali è possibile integrare un sistema di illuminazione a led.

FR La structure offre ne liberté de composition optimale et permet de créer des solutions sur mesure, adossées ou autoportantes, en fonction des diverses exigences. Sa polyvalence s'exprime également au niveau esthétique, grâce aux diverses finitions disponibles pour les couvertures : nattes en bambou, toiles coulissantes en tissu acrylique et lattes en bois sur lesquelles il est possible d'intégrer un système d'éclairage à LED.

FREE STANDING



Wall-mounted pergola / Pergola addossata / Pergola adossée

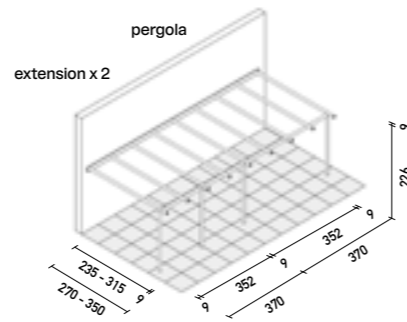
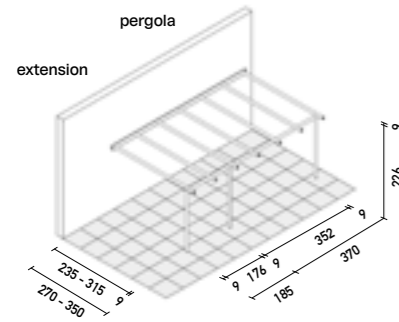

W 370 D 270 - 350

Extension / Estensione / Extension

Pergola / Pergola / Pergola W 370	
D 270	PESADD43
D 350	PESADD44

Extension / Estensione / Extension W 185	
D 270	ESPESADD43
D 350	ESPESADD44

Freestanding pergola / Pergola autoportante / Pergola autoportante

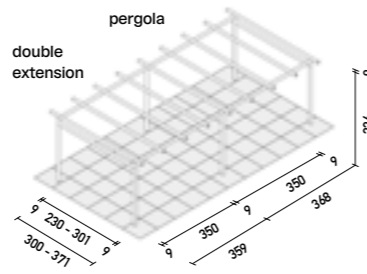
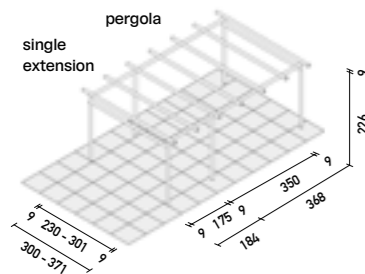

W 368 D 300 - 371

Extension / Estensione / Extension

Pergola / Pergola / Pergola W 368		Single extension / Estensione singola / Extension simple W 184	Double extension / Estensione doppia / Extension double W 359
D 300	PESAUT43	D 300	ESPESAUT43
D 371	PESAUT44	D 371	ESPESAUT44

Accessories / Accessori / Accessoires

Additional pillar for freestanding Ø 88 H 245 / Pilastro aggiuntivo per autoportante Ø 88 H 245 / Pilier supplémentaire autoportante Ø 88 H 245	99PRO9245AGC
Adjustable bracket for fixing to ground / Staffa regolabile per fissaggio a terra / Support réglable pour la fixation au sol	PIASAPR1
Half pillar H 215 wall fixing for trellises / Mezzo pilastro H 215 fissaggio a parete per tralci / Fixation murale demi-pilier H 215 pour treillis	99PRO44215AGC
Additional pillar for attached pergola Nagi Ø 88 H 215 / Pilastro aggiuntivo per addossata Ø 88 H 245 / Pilier supplémentaire adossée Ø 88 H 245	99PRO9215AGC
Additional beam for Nagi pergola pesadd43 Ø 88 H 232 / Trave supplementare per pergola Nagi pesadd43 Ø 88 H 232 / Poutre supplémentaire pour pergola Nagi pesadd43 Ø 88 H 232	99PRO9232AGC
Additional beam for Nagi pergola pesadd44 Ø 88 H 305 / Trave supplementare per pergola Nagi pesadd44 Ø 88 H 305 / Poutre supplémentaire pour pergola Nagi pesadd44 Ø 88 H 305	99PRO9305AGC

Bamboo shades / Stuoie di canne di bambù / Nattes en cannes de bambou

Shade kit made with bamboo canes of varying diameter (from 1 to 2 cm) connected by a stainless steel wire. Kits are supplied complete with fittings / Kit di stuoie realizzate con canne di bambù di sezione variabile (da cm 1 a cm 2 ca.) e unite da un filo passante di acciaio inox. I kit sono completi di fissaggi / Kit de nattes en cannes de bambou de section variant de 1 à 2 cm, reliées par un fil d'acier inoxydable, avec fixations.

Bamboo shades / Stuoie di canne di bambù / Nattes en cannes de bambou	W 185 D 250	BAMR
---	-------------	------

Compatible with the following pergola and extension codes / Abbinabili con i seguenti codici di pergole ed estensioni / Peut être associée avec les codes suivants de pergolas et extensions

ESPESADD43 - ESPESADD44 - ESPESAUT43 - ESPESAUT44	COBAM3L
PESADD43 - PESAUT43 - EPESAUT43	COBAM4L
PESADD44 - PESAUT44 - ESPESAUT44	COBAM5L

Nuage shade / Telo mare / Toile mer

Waterproof shade (29% polyester coated with 71% PVC) white for freestanding pergola Nagi / Telo impermeabile (poliestere 29% spalmato di PVC 71%) di colore bianco per pergola autoportante Nagi / Toile imperméable (29% polyester - enduit 71%PVC), blanche pour pergola autoportante Nagi

For freestanding pergola Art. PESAUT44 / Per pergola autoportante Art. PESAUT44 / Pour pergola autoportante Ref. PESAUT44	TMSH44
With 1 extension / Con 1 estensione / Avec 1 extension	TMSH44E1
With 2 extension / Con 2 estensioni / Avec 2 extension	TMSH44E2

To order roofing for pergola with more than 2 extensions, substitute the "2" in the relative code for pergolas with 2 extensions with the number of those required (e.g. TMSH44E3 - TMSH44E4) / Per ordinare coperture di pergole con più di 2 estensioni, sostituire il "2" nei codici relativi alle pergole con 2 estensioni con il numero di quelle previste (es. TMSH44E3 - TMSH44E4) / Pour commander les couvertures de pergolas ayant plus de 2 extensions, remplacer le "2" dans les codes de référence des pergolas à 2 extensions, avec le numéro des pergolas désirées (ex. TMSH44E3 - TMSH44E4)

Special brackets / Staffe speciali / Équerres spéciales



SL brackets: to fix any section to the ground, 10 Ø bolts and plugs are required / Staffe SL: per fissare a terra qualunque profilo, necessitano di bulloni Ø 10 e tasselli / Équerres SL : pour fixer au sol tous types de profilé ; des boulons Ø 10 et des chevilles sont nécessaires.

width	height	length	thickness	
60	40	190	5	SL



SP30 screen brackets: to fix various panels to posts or walls. SRI-SBA: to fix posts to railings or balustrades / Staffe per schermature SP30N: per il fissaggio dei vari pannelli sia ai pilastri che a muro. SRI-SBA: per fissare i pilastri sia alla ringhiera che sulla balaustra / Équerres pour fermeture SP30, pour fixer différents panneaux aux piliers ou à la paroi. SRI - SBA, pour fixer les piliers à une rambarde ou balustrade.

width	height	length	thickness	
-	-	-	-	SP30N
-	-	-	-	SBA
-	-	-	-	SRI

Floor brackets / Staffe a terra / équerres fixation sol



Nerved brackets in galvanized iron to fix 90 x 90 posts raised from the ground, complete with hardware. Plugs for fixing to the ground excluded. To be used only with attached structures / Staffa nervata rialzata in ferro zincato per il fissaggio sollevato da terra di pilastri 90 x 90 completa di ferramenta. Tasselli per l'ancoraggio a terra esclusi. Da utilizzare esclusivamente su strutture adossate / Equerre nervurée réhaussée en fer galvanisé pour fixation surélevée des piliers du sol 90 x 90, visserie incluse. Chevilles pour fixation au sol exclues. Utiliser uniquement pour structure adossée.

width	height	length	thickness	
100	160	80	5	SRU99C



Double raised brackets in galvanized iron to fix 90 x 90 and 70 x 70 posts raised from the ground. The brackets are complete with hardware. Plugs to fix to ground are excluded / Staffe rialzate doppie in ferro zincato per il fissaggio sollevato da terra di pilastri 90 x 90 e 70 x 70. Le staffe sono complete di ferramenta. Tasselli per l'ancoraggio a terra esclusi / Equerre réhaussée doubles en fer galvanisé pour fixation surélevée des piliers du sol 90 x 90 et 70 x 70. Les équerres sont livrées avec visserie. Chevilles pour fixation au sol exclues.

width	height	length	thickness	
195	190	90	3	SRCD99C
175	190	70	3	SRCD77C

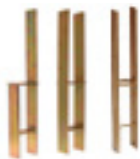

Clamps used to fix 90 x 90 (SINT) posts to the ground. Ref. SINT1 is used to fix square corner posts where structures are to be closed laterally / Zanche per fissare a terreno pilastri 90 x 90 (SINT). L'art. SINT1 si utilizza per il fissaggio a terra dei pilastri quadrati d'angolo in strutture da chiudere lateralmente / Support pour fixer au sol des piliers 90 x 90 (SINT). Le support Réf. SINT1 est utilisé pour la fixation au sol de piliers d'angle à section carrée dans les structures à fermer latéralement.

width	height	length	thickness	
102	606	60	6	SINT
102	606	60	6	SINT1
102	606	60	6	SINTR

Laminar sections / Profili lamellari / Profilés lamellés



Available in 2100 and 2200 mm, lengths and used as load bearing posts in almost all Unopiù structures ensuring optimum mechanical performance / Disponibili di lunghezza mm 2100 e 2200, sono utilizzati come pilastri portanti in quasi tutte le strutture Unopiù e permettono di ottenere soluzioni meccaniche più spinte / Disponibles en 2100 et 2200 mm de longueur, ils sont utilisés comme piliers portants pour presque toutes les structures Unopiù et permettent de réaliser des solutions mécaniques plus solides.

section	length		
90 x 90	2200	PL9922V	
Ø 68	2100	PR682SH	

Solid posts / Pilastri di massello / Piliers en bois massif



Available in various lengths and used as struts, in pairs, and as load bearing beams on very light structures / Disponibili in diverse lunghezze sono utilizzati nelle schermature, per il fissaggio dei pannelli, o per ottenere strutture molto leggere / Disponibles en plusieurs longueurs, ils sont utilisés pour les clôtures, pour fixer les panneaux ou pour réaliser des structures très légères.

section	length		
70 x 70	2090	P7721V	
70 x 70	1250	P7712FV	

Screws - Plugs / Viti - Tasselli / Vis - Chevilles



Screws: galvanized and tropicalized, like all hardware, available in 3 sizes / Viti: tropicalizzate zincate, come il resto della ferramenta, sono disponibili in tre misure / Vis : tropicalisées et galvanisées comme toutes nos ferrures, sept mesures disponibles.

Ø	W	
6	100	V610
6	110	V611
6	130	V613



Plugs TE plugs: 10 Ø, to fix wood to brickwork or concrete. TF plugs: 16 Ø in steel, to fix any bracket to brick or concrete / Tasselli ad espansione. Tasselli TE: Ø 10, per fissare il legno a muratura e a cemento. Tasselli TF: elementi in acciaio Ø 16, per fissare a mattone pieno o cemento ogni staffa / Chevilles à expansion. Chevilles TE : Ø 10 pour fixer les éléments en bois à la maçonnerie et au ciment. Chevilles TF : éléments en acier Ø 16 pour fixer les équerres sur de la brique pleine ou du ciment.

Ø	W	
10	160	TE
16	80	TF



Chemical plugs: special plugs which can bond with any material (hollow bricks, tufa, etc). Supplied in packs of 6 with installation accessories / Tasselli chimici, speciali elementi che hanno la possibilità di far presa su qualsiasi tipo di materiale (forati, tufo, ecc.). Vengono forniti in confezioni da 6 pz., con gli accessori per l'installazione / Chevilles chimiques: pièces spéciales qui permettent de faire prise sur n'importe quel type de matériau (briques creuses, tuf, etc.), fournies en lots de 6 pièces avec accessoires pour la mise en place.

Ø	W	
16	110	TC6SP

Sections and Grill accessories / Profili - Accessori per grigliati / Accessoires en bois - Fer



Crowning beam / Trave di coronamento / Poutre de couronnement

W 4.5 x 9.5 x 400 T45954CV



Sphere / Sfera / Sphère

Ø 7 SFE70V



Post for side support of various panels / Pilastro per il sostegno laterale dei vari pannelli / Pilier pour le soutien lateral des différents panneaux

H 210 P7721V



Post for side support of various panels / Pilastro per il sostegno laterale dei vari pannelli / Pilier pour le soutien lateral des différents panneaux

H 125 P7712FV



Wooden dowel for fixing balustrade / Tassello in legno per fissaggio a balaustra / Ancre en bois pour fixage à balustrade

L 7 P 4 H 7 BDF4



Bracket to fix panel / Staffa fissaggio pannelli / Équerre de fixation panneaux

SP30N

Wood slat roofing / Copertura in listelli di legno / Couverture en lambris de lattes de bois

Panels of treated nordic pine wood slats with optional LED lighting / Pannelli a listelli di pino nordico impregnato con illuminazione a LED opzionale / Panneaux en lambris de lattes de bois en pin nordique imprégné avec illumination LED en option.

LED characteristics: 13200mAh – 2700k – 600lm / Caratteristiche LED: 13200mAh - 2700k - 600lm / Caractéristiques LED : 13200mAh - 2700k - 600lm

Recharge: solar – USB / Ricarica: solare - USB / Recharge : solaire - USB



Slat roofing / Copertura a listelli / Couverture en lambris de lattes de bois

For pergola / Per pergola / Pour pergola pesadd43	COADSH43
For extension / Per estensione / Pour extension esesadd43	COADSH43ES
For pergola / Per pergola / Pour pergol pesadd44	COADSH44
For extension / Per estensione / Pour extension esesadd44	COADSH44ES
For pergola / Per pergola / Pour pergol pesaut43	COAUSH43
For single extension / Per estensione singola / Pour extension simple esesaut43	COAUSH43ES
For double extension / Per estensione doppia / Pour double extension edpesaut43	COAUSH43ED
For pergola / Per pergola / Pour pergol pesaut44	COAUSH44
For single extension / Per estensione singola / Pour extension simple esesaut44	COAUSH44ES
For double extension / Per estensione doppia / Pour double extension edpesaut44	COAUSH44ED

Slat roofing with LED / Copertura a listelli con LED / Couverture en lambris de lattes de bois avec LED

For pergola / Per pergola / Pour pergola pesadd43 (n. 4 Led)	COADSH43LED
For extension / Per estensione / Pour extension esesadd43 (n. 2 Led)	COADSH43ESLED
For pergola / per pergola / Pour pergola pesadd44 (n. 4 Led)	COADSH44LED
For extension / Per estensione / Pour extension esesadd44 (n. 2 Led)	COADSH44ESLED
For pergola / per pergola / Pour pergola pesaut43 (n. 4 Led)	COAUSH43LED
For single extension / Per estensione singola / Pour extension simple esesaut43 (n. 2 Led)	COAUSH43ESLED
For double extension / Per estensione doppia / Pour double extension edpesaut43 (n. 4 Led)	COAUSH43EDLED
For pergola / per pergola / Pour pergola pesaut44 (n. 4 Led)	COAUSH44LED
For single extension / Per estensione singola / Pour extension simple esesaut44 (n. 2 Led)	COAUSH44ESLED
For double extension / Per estensione doppia / Pour double extension edpesaut44 (n. 4 Led)	COAUSH44EDLED

Roll shade / Telo roll / Toile roll

Compatible with Nagi pergolas supplied complete with aluminium casing, ivory gloss finish, spring loaded roller and tracks / Compatibile con la pergola Nagi viene fornito completo di coprirullo in alluminio smaltato di colore avorio, avvolgibile a molla e guide / Compatible avec la pergola Nagi fournie avec coffre rouleau en aluminium laqué ivoire, enrouleur à ressort et glissières.

Adjustable shade 100% acrylic colour écru Telo regolabile di acrilico 100% di colore écru Toile réglable 100% acrylique couleur écru	W 372 D 400 (For pergola / Per pergola / Pour pergola)	ROLLSH
	W 186 D 400 (For extension / Per estensione / Pour extension)	ROLLSHE

Trellises / Grigliati / Treillages

Diamond pattern / Grigliati a maglia romboidale / Treillages maille losange



75 X 115	GRCRI711
75 X 148	GRCRI714
148 x 115	GRCRI1411
148 X 148	GRCRI1414
220 X 115	GRCRI2111
220 X 148	GRCRI2114

Square pattern / Grigliati a maglia quadrata / Treillages maille carrée



75 X 115	GRQU711
75 X 148	GRQU714
148 x 115	GRQU1411
148 X 148	GRQU1414
220 X 115	GRQU2111
220 X 148	GRQU2114

Rectangular planters / Fioriere rettangolari / Jardinières rectangulaires



planter

Planter for square post / Fioriera per palo quadrato / Jardinière pour pilier carré	L 75 W 45 H 44	FRSH7545
Planter for round post / Fioriera per palo rotondo / Jardinière pour pilier rond	L 75 W 45 H 44	FRSH7545R



extension

Planter extension for square post / Estensione fioriera per palo quadrato / Extension jardinière pour pilier carré	L 69 W 45 H 44	ESFRSH7545
Planter extension for round post / Estensione fioriera per palo rotondo / Extension jardinière pour pilier rond	L 69 W 45 H 44	ESFRSH7545R

Finishes / Finiture / Finitions



Nordic pine painted in bankirai Colour
Pino nordico verniciato bankirai
Pin nordique peint en couleur bankirai



Painted wooden slats
Listelli di legno verniciati
Lattes de bois vernis



Bamboo mat
Stuoia bambù
Natte de bambou



Waterproof fabric in 29% polyester coated with 17% PVC white
Telo impermeabile poliester e 29%
Tissu imperméable 29% polyester enduit 17% PVC blanc

Orangerie

Orangerie is a classically inspired greenhouse system made from galvanised and powder-coated iron with a polycarbonate covering designed to recreate a green environment that is ideal for growing and nurturing plants outside their natural environment.

IT Orangerie è un sistema di serre d'ispirazione classica, in ferro zincato e verniciato a polveri con copertura in policarbonato pensata per ricrearsi un'ambiente verde, ideale per coltivare e prendersi cura delle piante fuori dal loro ambiente naturale.

FR Orangerie est une serre d'inspiration classique en fer galvanisé peint revêtu de poudre. Dotée d'une couverture en polycarbonate, elle permet de recréer un espace vert idéal pour cultiver et prendre soin des plantes en dehors de leur environnement naturel.







Offered in two models, free-standing and wall-mounted, it can adapt to any space. The structure features large polycarbonate surfaces, which are effective at allowing natural, continuous lighting inside. Most of them can be opened to allow the regulation of air flow and to ensure ventilation for the plants.

FREE STANDING

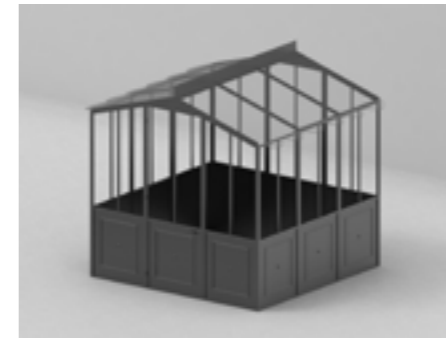

WALL-MOUNTED

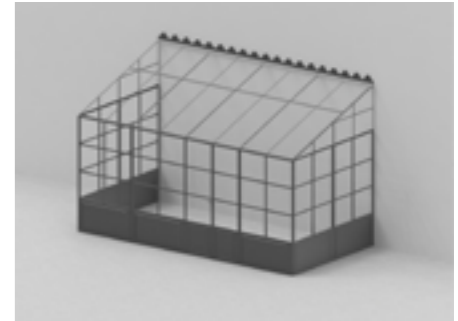
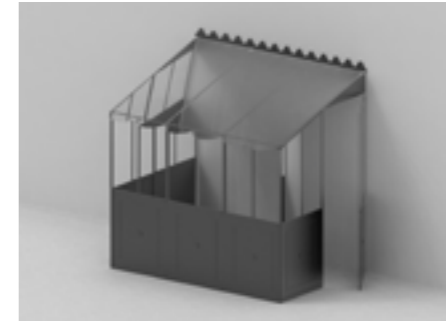

IT Proposta in due modelli, autoportante e addossata, è capace di soddisfare ogni esigenza di spazio.

La struttura è caratterizzata da ampie superfici in policarbonato, efficaci per permettere una naturale e costante illuminazione all'interno. La maggior parte di esse sono apribili, per consentire la regolazione dell'aria e garantire la ventilazione delle piante.

FR Proposée en deux modèles, autoportante et adossée, elle répond à tous les besoins en terme d'espace.

La structure se caractérise par de grandes surfaces en polycarbonate qui permettent d'obtenir un éclairage naturel et constant à l'intérieur. La plupart des modèles sont ouvrables, ce qui assure une régulation de l'air et une bonne ventilation des plantes.



Orangerie

- Iron graphite / Ferro color grafite / Fer couleur graphite
- Polycarbonate embossed / Policarbonato goffrato / Polycarbonate gaufré

Freestanding greenhouse / Serra autoportante / Serre autoportante

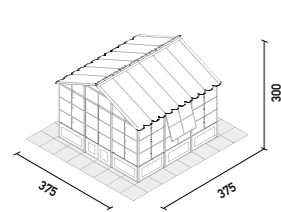

W 375 D 375 H 300

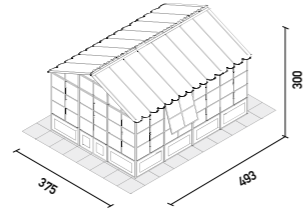

W 375 D 493 H 300

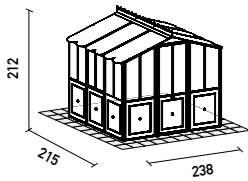

W 238 D 215 H 212

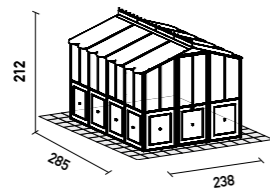

W 238 D 285 H 212

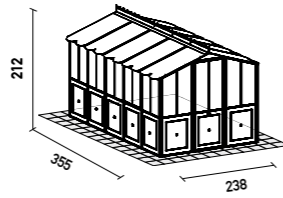

W 238 D 355 H 212

Greenhouse with polycarbonate roofing, 1 window and 1 door with polycarbonate side panelling
Serra con copertura di policarbonato, 1 finestra e 1 porta con pannellatura laterale di policarbonato
Serre avec couverture en polycarbonate gaufré, 1 fenêtre et 1 porte avec panneaux latéraux en polycarbonate

W 375 D 375 H 300 SAU33P

W 375 D 493 H 300 SAU34P

W 238 D 215 H 212 SAU215

Greenhouse with 1 window and 1 door
Serra completa di 1 finestra e 1 porta
Serre complète avec 1 fenêtre et 1 porte

W 238 D 285 H 212 SAU285

W 238 D 355 H 212 SAU355

Windows-Doors / Finestre - Porte / Fenêtres - Portes

Supplement for additional window panel with polycarbonate panel (for SAU33P, SAU34P, SAD32P, SAD42P)
Supplemento per ulteriore pannello finestra con lastre di policarbonato (per SAU33P, SAU34P, SAD32P, SAD42P)
Supplément pour panneau fenêtre supplémentaire avec plaques en polycarbonate (SAU33P, SAU34P, SAD32P, SAD42P)

SPFSOR

Supplement for additional door panel with polycarbonate panel (for SAU33P, SAU34P, SAD32P, SAD42P)
Supplemento per ulteriore pannello porta con lastre di policarbonato (per SAU33P, SAU34P, SAD32P, SAD42P)
Supplément pour panneau porte supplémentaire avec plaques en polycarbonate (SAU33P, SAU34P, SAD32P, SAD42P)

SPPSOR

Supplement for additional window panel (for SAU215, SAU285, SAU355 SADSX215, SADDX215, SADSX285, SADDX285, SADSX355, SADDX355)
Supplemento per ulteriore pannello finestra (per SAU215, SAU285, SAU355 SADSX215, SADDX215, SADSX285, SADDX285, SADSX355, SADDX355)
Supplément pour panneau fenêtre supplémentaire (SAU215, SAU285, SAU355, SADSX215, SADDX215, SADSX285, SADDX285, SADSX355, SADDX355)

SUPFINSER

Orangerie

- Iron graphite / Ferro color grafite / Fer couleur graphite
- Polycarbonate embossed / Policarbonato goffrato / Polycarbonate gaufré

Wall-mounted greenhouse / Serra addossata / Serre adossée

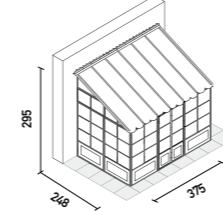

W 375 D 248 H 295

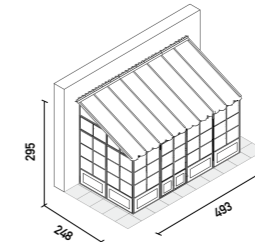

W 493 D 248 H 295

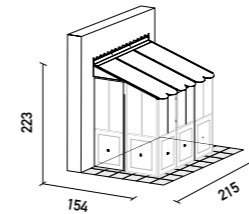

W 215 D 154 H 223

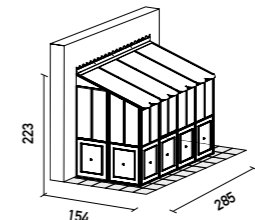

W 285 D 154 H 223

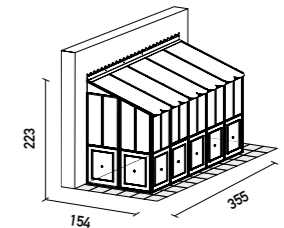

W 355 D 154 H 223

Greenhouse with polycarbonate roofing, 1 window and 1 door with polycarbonate side panelling
Serra con copertura di policarbonato, 1 finestra e 1 porta con pannellatura laterale di policarbonato
Serre avec couverture en polycarbonate, 1 fenêtre et 1 porte avec panneaux latéraux en polycarbonate

W 375 D 248 H 295 SAD32P

W 493 D 248 H 295 SAD42P

Greenhouse with 1 window and 1 door left opening
Serra completa di 1 finestra e 1 porta apertura a sinistra
Serre complète avec 1 fenêtre et 1 porte ouverture à gauche

W 215 D 154 H 223 SADSX215

W 285 D 154 H 223 SADSX285

W 355 D 154 H 223 SADSX355

Greenhouse with 1 window and 1 door right opening
Serra completa di 1 finestra e 1 porta apertura a destra
Serre complète avec 1 fenêtre et 1 porte ouverture à droite

W 215 D 154 H 223 SADDX215

W 285 D 154 H 223 SADDX285

W 355 D 154 H 223 SADDX355

Finishes / Finiture / Finitions

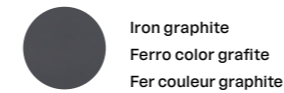

Salento

Salento is a collection of parasols with a contemporary style, featuring a practical lateral support pole. The opening of the awning is available in both motorised and manual versions, to meet different functional and aesthetic needs.

IT Salento è una collezione di ombrelloni dallo stile contemporaneo, caratterizzati dal pratico palo di sostegno laterale. L'apertura della tenda da sole è disponibile sia motorizzata che manuale, per rispondere alle diverse esigenze funzionali ed estetiche.

FR Salento est une collection de parasols au style contemporain, caractérisés par un mât de soutien latéral très pratique. L'ouverture de la toile est disponible en version motorisée ou manuelle pour répondre aux diverses exigences fonctionnelles et esthétiques.







The base is designed to be used with concrete tiles, sold separately from the structure, which guarantee the equilibrium and balance of the product without invading the space below the covering.

IT La base è pensata per poter accogliere le piastrelle in cemento, vendute separatamente dalla struttura, che garantiscono l'equilibrio e il bilanciamento del prodotto senza invadere lo spazio sottostante alla copertura.

FR La base est conçue pour pouvoir accueillir les plaques en ciment, vendues séparément de la structure, qui garantissent l'équilibre et la stabilité du produit sans envahir l'espace situé sous la couverture.



- Galvanized steel / Acciaio zincato / Acier thermolaqué
- Lamellar iroko, wood / Legno lamellare di iroko / Bois d'iroko
- Aluminum / Alluminio / Aluminium
- 100% acrylic fabric / Tessuto acrilico 100% bianco / 100% acrylique blanc

Umbrellas / Ombrelloni / Parasols

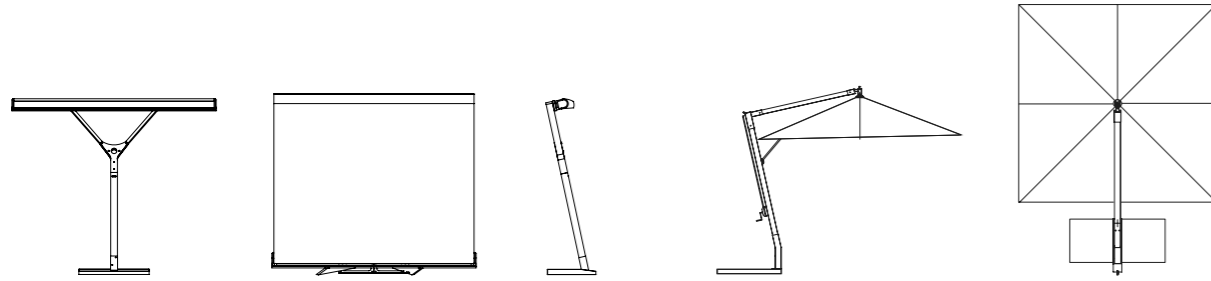

W 300 D 250 H 243

W 285 D 285 H 328

Umbrella in white steel and iroko wood with white shade, manual opening
Ombrellone in acciaio bianco e legno di iroko con telo bianco, apertura manuale
Parasol en acier galvanisé et thermolaqué blanc et bois d'iroko avec toile blanche, ouverture manuelle

OSAMAB

Umbrella in bronze steel and iroko wood with écreu shade, manual opening
Ombrellone in acciaio bronzo e legno di iroko con telo écreu, apertura manuale
Parasol en acier thermolaqué bronze et bois d'iroko avec toile écreu avec toile blanche écreu, ouverture manuelle

OSAMABR

Umbrella in white steel and iroko wood with white shade, motorized opening
Ombrellone in acciaio bianco e legno di iroko con telo bianco, apertura motorizzata
Parasol en acier thermolaqué blanc et bois d'iroko avec toile blanche

OSAMOB

Umbrella in bronze steel and iroko wood with écreu shade, motorized opening
Ombrellone in acciaio bronzo e legno di iroko con telo écreu, apertura motorizzata
Parasol en acier thermolaqué bronze et bois d'iroko avec toile écreu, ouverture motorisée

OSAMOBR

Umbrella square 285 x 285 H 328, side structure aluminium in white
Ombrellone quadrato 285 x 285 H 328, struttura laterale alluminio bianco
Parasol carré 285 x 285 H 328, structure latérale aluminium blanc

OMABALB

Umbrella square 285 x 285 H 328, side structure aluminium in graphite
Ombrellone quadrato 285 x 285 H 328, struttura laterale alluminio grafite
Parasol carré 285 x 285 H 328, structure latérale aluminium graphite



OMABALG

Umbrella square 285 x 285 H 328, side structure aluminium wood effect
Ombrellone quadrato 285 x 285 H 328, struttura laterale effetto legno
Parasol carré 285 x 285 H 328, structure latérale aluminium effet bois

OMABALL

- Galvanized steel / Acciaio zincato / Acier thermolaqué
- Lamellar iroko, wood / Legno lamellare di iroko / Bois d'iroko
- Aluminum / Alluminio / Aluminium
- 100% acrylic fabric / Tessuto acrilico 100% bianco / 100% acrylique blanc

Accessories / Accessori / Accessoires

	Set of 10 concrete blocks (for OSAMAB, OSAMABR OSAMOB, OSAMOBR) Set di 10 blocchi di cemento (per OSAMAB, OSAMABR, OSAMOB, OSAMOBR) Set de 10 dalles en ciment (pour OSAMAB, OSAMABR, OSAMOB, OSAMOBR)	OSABC
	Set of 6 tiles 50 x 50 in pebble concrete (for OMABALB, OMABALG, OMABALL) Set di 6 mattonelle 50 x 50 di cemento granigliato (per OMABALB, OMABALG, OMABALL) Set de 6 dalles de ciment granulé 50 x 50 (pour OMABALB, OMABALG, OMABALL)	BAOMCAL
	Taupe coloured square umbrella shade cover Copertura per telo ombrellone quadrato colore Taupe Housse pour toile parasol carré couleur Taupe	COOMABALL

Finishes / Finiture / Finitions

	Aluminum graphite Alluminio grafite Aluminium graphite		Aluminum wood effect Alluminio effetto legno Aluminium effet bois		Aluminum white Alluminio bianco Aluminium blanc
	Galvanized steel white gloss Acciaio zincato bianco lucido Acier thermolaqué blanc vern		Galvanized steel matt bronze Acciaio zincato bronzo Acier thermolaqué bronze		Lamellar iroko wood Legno lamellare iroko Bois d'iroko
	100% acrylic fabric in white Tessuto acrilico 100% bianco Tissu 100% acrylique blanc		100% acrylic fabric in ecru Tessuto acrilico 100% ecru Tissu 100% acrylique écreu		

Shibuya® is the first mobile pergola and has been designed by Ferruccio Laviani, who introduces the concept of dynamism by revolutionising the static architectural principle of traditional structures. The aluminium structure is available as a fixed unit that can be anchored to the ground or, alternatively, fixed onto four wheels equipped with a lock, to allow the utmost freedom of movement within a space.

IT Shibuya® è la prima pergola mobile, disegnata da Ferruccio Laviani che introduce il concetto di dinamismo rivoluzionando il principio architettonico di staticità delle strutture tradizionali. La struttura in alluminio è disponibile come unità fissa da ancorare al suolo o in alternativa fissata su quattro ruote dotate di blocco, per permettere la massima libertà di movimento nello spazio.

FR Shibuya®, la première pergola mobile, est une création de Ferruccio Laviani qui introduit le concept de dynamisme et révolutionne le principe architectural des structures traditionnelles de forme statique. La structure en aluminium est disponible en tant qu'unité fixe à ancrer au sol ou fixer sur quatre roues dotées d'un système de blocage qui offre une totale liberté de mouvement dans l'espace.







Free-standing or wall-mounted, the pergola is completed by different types of roofs, which guarantee excellent shelter from the sun, designing light, elegant shadows in the environment.

IT Autoportante o addossata, la pergola si completa con diverse tipologie di coperture, che garantiscono un ottimo riparo dal sole, disegnando ombre leggere ed eleganti nell'ambiente.

FR Autoportante ou adossée, la pergola peut être complétée de divers types de couvertures offrant une protection optimale contre le soleil et créant des ombres légères et élégantes dans l'environnement.



WALL-MOUNTED

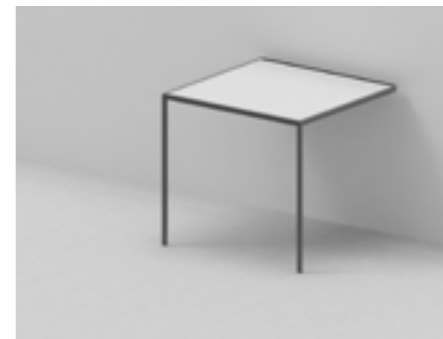
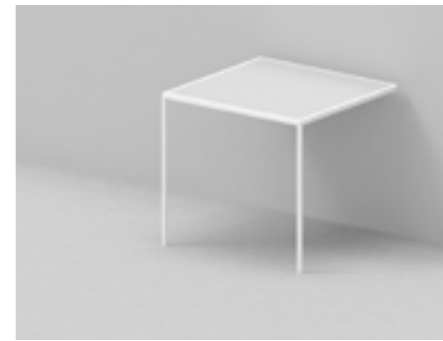

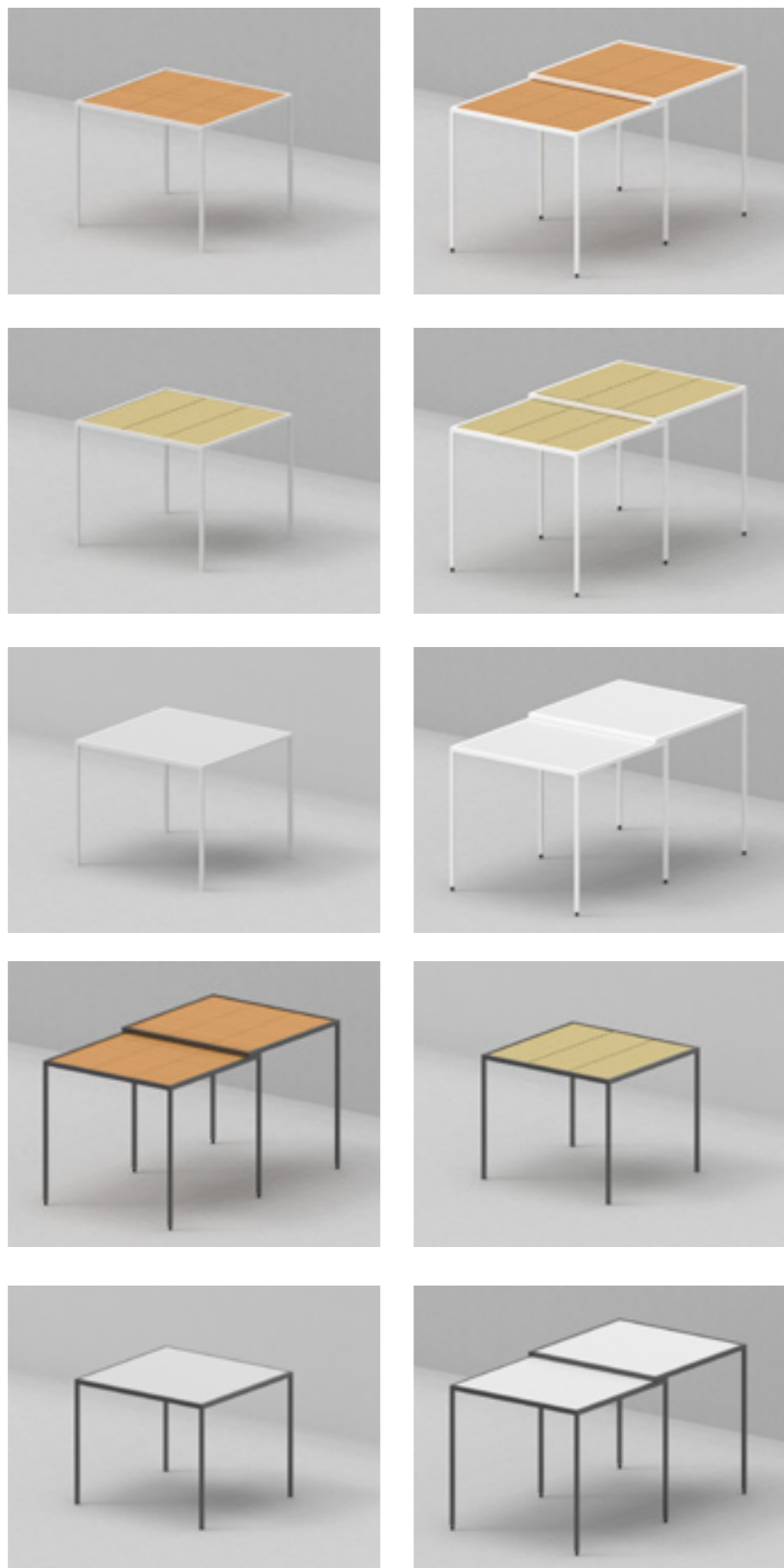

Wall-mounted pergola / Pergola addossata / Pergola adossée

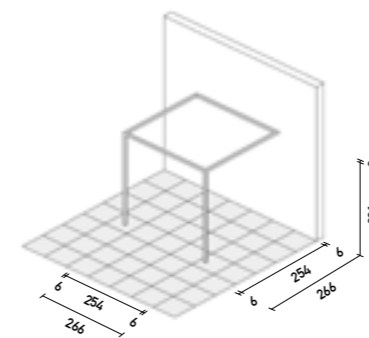

W 266 D 266

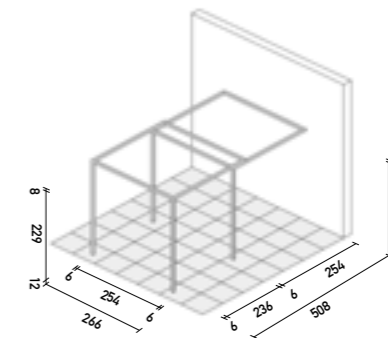

Extension / Estensione / Extension

Wall-mounted pergola / Pergola addossata / Pergola adossée

white / bianco / blanc	SHI33ALADB
graphite / grafite / graphite	SHI33ALADG

Freestanding pergola / Pergola autoportante / Pergola autoportante

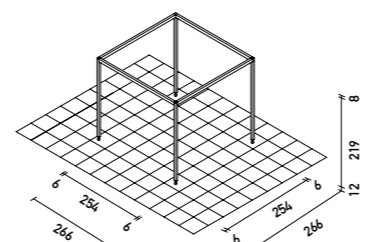

W 266 D 266

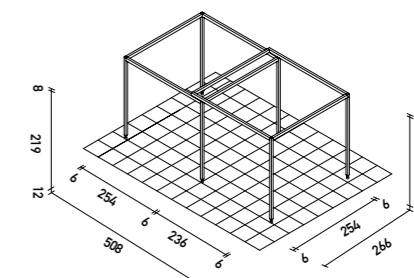

Extension / Estensione / Extension

Freestanding pergola / Pergola autoportante / Pergola autoportante

white / bianco / blanc	SHI33ALB
graphite / grafite / graphite	SHI33ALG

Extension / Estensione / Extension

Extension for freestanding and attached pergola W 272,5 D 266
 Estensione per pergola addossata e autoportante L 272,5 P 266
 Extension pour pergola adossée et autoportante L 272,5 P 266

white / bianco / blanc	SHI33ALESTB
graphite / grafite / graphite	SHI33ALESTG

Fixing kit excluded / Kit di fissaggio escluso / kit de fixation exclu

Microperforated shade / Telo microforato / Toile micro-perforée

structure colour / colore struttura / couleur structure	standard / base / base	extendable / estensibile / extensible
white / bianco / blanc	SHICM3QAB	SHICM3QABE
graphite / grafite / graphite	SHICM3QAG	SHICM3QAGE

Bamboo shade / Stuoie di bambù / Cannes de bambou

structure colour / colore struttura / couleur structure	standard / base / base	extendable / estensibile / extensible
white / bianco / blanc	SHICB3QAB	SHICB3QABE
graphite / grafite / graphite	SHICB3QAG	SHICB3QAGE

Wooden slats (painted) / Listelli di legno (verniciati) / Lattes de bois (traitées)

structure colour / colore struttura / couleur structure	standard / base / base	extendable / estensibile / extensible
white / bianco / blanc	SHICL3QAB	SHICL3QABE
graphite / grafite / graphite	SHICL3QAG	SHICL3QAGE

Side blinds / Tende perimetrali / Stores latéraux

Blind W 254 for pergola in white Tenda L 254 per pergola di colore bianco Store L 254 pour pergola blanche	SHITE3QB
--	----------

Blind W 254 for pergola in graphite Tenda L 254 per pergola di colore grafite Store L 254 pour pergola couleur graphite	SHITE3QG
---	----------

Accessories / Accessori / Accessoires

Pair of brackets for fixing/blocking post-parapet/wall for fixed and mobile pergolas, white Coppia di staffe fissaggio/stazionamento pilastro-parapetto/muro per pergola fissa/mobile bianca Paire d'équerres pour fixation/stationnement pilier-parapet pour pergola fixe et mobile blanche	STAPSHI2B
--	-----------

Pair of brackets for fixing/blocking post-parapet/wall for fixed and mobile pergolas, graphite Coppia di staffe fissaggio/stazionamento pilastro-parapetto/muro per pergola fissa/mobile grafite Paire d'équerres pour fixation/stationnement pilier-parapet pour pergola fixe et mobile couleur graphite	STAPSHI2G
---	-----------

Pair of brackets for fixing/blocking post-railing for fixed and mobile pergolas, white Coppia di staffe fissaggio/stazionamento pilastro-ringhiera per pergola fissa/mobile bianca Paire d'équerres pour fixation/stationnement pilier-balustrade pour pergola fixe et mobile blanche	STARSHI2B
---	-----------

Pair of brackets for fixing/blocking post-railing for fixed and mobile pergolas, graphite Coppia di staffe fissaggio/stazionamento pilastro-ringhiera per pergola fissa/mobile grafite Paire d'équerres pour fixation/stationnement pilier-balustrade pour pergola fixe et mobile couleur graphite	STARSHI2G
--	-----------

Bracket removable to fix the mobile pergola to the ground (2 brackets are required per pergola), white Staffa removibile per posizionamento a terra pergola mobile (necessarie n. 2 staffe per pergola) bianca Équerre enlevable pour positionner la pergola mobile au sol (utiliser 2 équerres par pergola) blanche	STATSHIB
--	----------

Bracket removable to fix the mobile pergola to the ground (2 brackets are required per pergola), graphite Staffa removibile per posizionamento a terra pergola mobile (necessarie n. 2 staffe per pergola) grafite Équerre enlevable pour positionner la pergola mobile au sol (utiliser 2 équerres par pergola) couleur graphite	STATSHIG
---	----------

Bracket in white for fixing to ground, white Staffa di fissaggio a terra bianca Équerre de fixation au sol blanche	SHISTAFB
--	----------

Bracket in white for fixing to ground, graphite Staffa di fissaggio a terra grafite Équerre de fixation au sol couleur graphite	SHISTAFG
---	----------

Kit of 2 wheels Ø 10 Kit n. 2 ruote Ø 10 Kit de 2 roues Ø 10	KITRUSHI2
--	-----------

Finishes / Finiture / Finitions

 Aluminium powder coated graphite Alluminio verniciato a polveri grafite Aluminium galvanisé et thermolaqué graphite	 Aluminium powder coated white Alluminio verniciato a polveri bianco Aluminium galvanisé et thermolaqué blanc
---	--

 Beige microperforated sheet Telo beige microforato Tôle microperforée beige

 Bamboo mat Stuoia bambù Natte de bambou

 Painted wooden slats Listelli di legno verniciati Lattes de bois vernis

The Solaire pergola collection stands out due to its traditional, ornamental style, which is reminiscent of the classical lines of historic Italian garden architecture. Its characteristics makes it an intermediate indoor/outdoor complement suited to every home, with which it generates a harmonious dialogue. Its timeless style makes it the ideal complement to the historic Unopiù lines.

IT La collezione di pergole Solaire si distingue per il sapore tradizionale ed ornamentale, che richiama lo stile classico delle storiche architetture dei giardini all'italiana. La sua funzione la rende un complemento intermedio tra interno ed esterno necessario per ciascuna abitazione, con cui genera un armonioso dialogo. Il suo stile senza tempo la rende il completamento ideale delle storiche linee di Unopiù.

FR La collection de pergolas Solaire se distingue par son caractère traditionnel et ornemental qui rappelle le style classique des architectures historiques des jardins à l'italienne. La pergola est un élément intermédiaire entre l'extérieur et l'intérieur de la maison, avec laquelle elle instaure un dialogue harmonieux. Son style intemporel en fait un complément idéal des lignes historiques d'Unopiù.







The solid frame in powder-coated galvanized iron becomes a decorative element and is available on all models: wall-mounted, free-standing or in the form of a pavilion with a round or octagonal floorplan. The many coverings, available in various finishes, adapt to all the different types, completing the product with sophistication and elegance.

FREE STANDING



WALL-MOUNTED

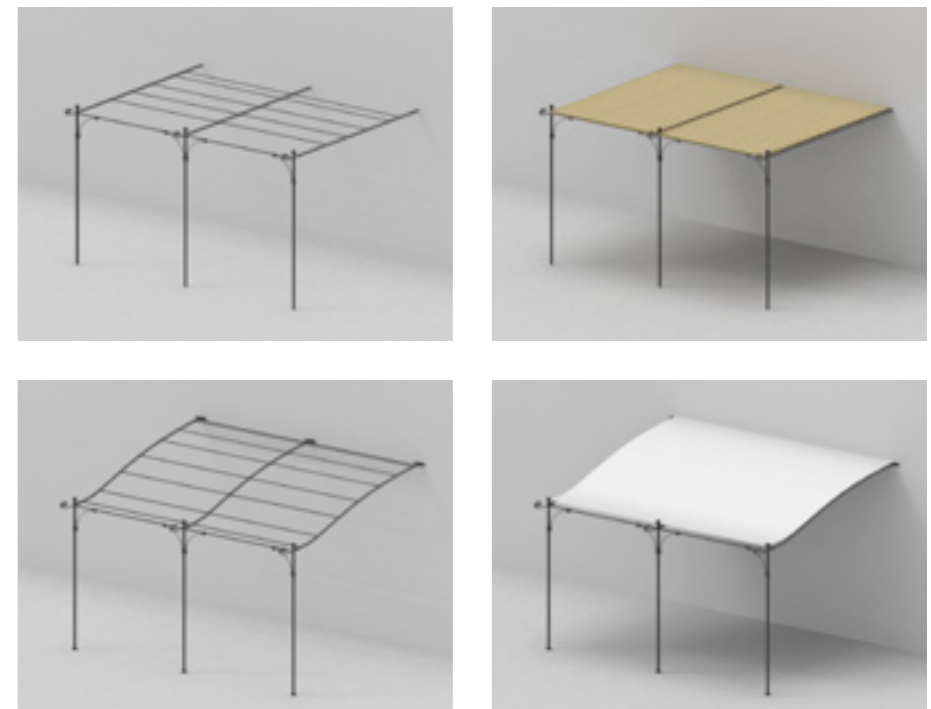

IT Lo scheletro solido in ferro zincato verniciato a polveri diventa elemento decorativo ed è disponibile in tutti i modelli: addossata, autoportante e sotto forma di padiglione a pianta rotonda o ottagonale. Le molteplici coperture, disponibili in diverse finiture si adattano a tutte le tipologie, completando con raffinatezza ed eleganza il prodotto.

FR La structure solide en fer galvanisé peint revêtu de poudre devient un élément décoratif. Il est disponible dans tous les modèles : adossée, autoportante et sous forme de pavillon rond ou octogonal. Les couvertures, proposées avec diverses finitions, s'adaptent à tous les types de structure et y apportent une touche de raffinement et d'élégance.



Wall-mounted pergola curved roof / Pergola addossata curva / Pergola adossée courbée

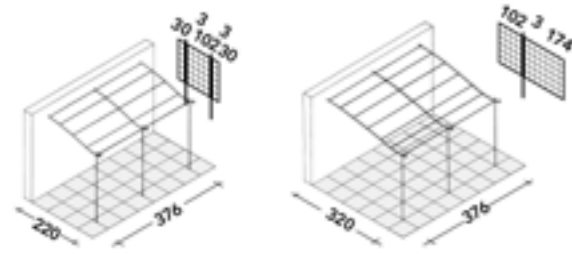

W 376 D 220 - 320

Pergola W 376 / Pergola / Pergola

D 220	PSW2C
D 320	PSW3C

Extension W 186 / Estensione / Extension

D 220	PSW2EC
D 320	PSW3EC

Freestanding pergola curved roof / Pergola autoportante curva / Pergola autoportante courbée

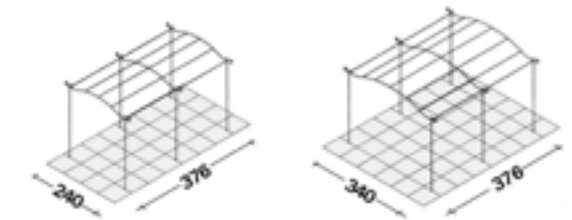

W 376 - 240 - 340

Pergola W 376 / Pergola / Pergola

D 240	PSA2C
D 340	PSA3C

Extension W 186 / Estensione / Extension

D 240	PSA2EC
D 340	PSA3EC

Wall-mounted pergola flat roof / Pergola addossata piana / Pergola adossée plate

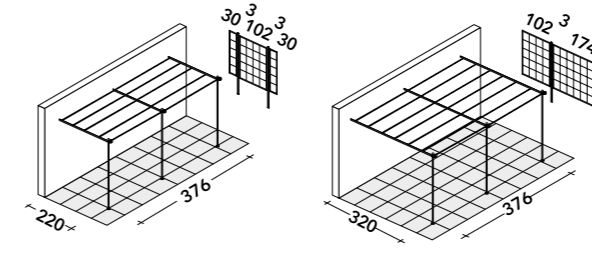

W 376 D 220 - 320

Pergola W 376 / Pergola / Pergola

D 220	PSP2C
D 320	PSP3C

Extension W 186 / Estensione / Extension

D 220	PSP2EC
D 320	PSP3EC

Freestanding pergola flat roof / Pergola autoportante piana / Pergola autoportante plate

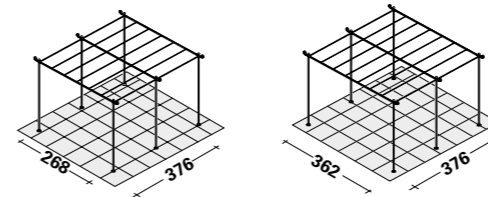

W 376 D 268 - 362

Pergola W 376 / Pergola / Pergola

D 268	PSAP2C
D 362	PSAP3C

Extension W 186 / Estensione / Extension

D 268	PSAP2EC
D 362	PSAP3EC

Dimensions given in the technical illustration refer to the maximum area occupied. The beam decoration overhangs the posts by approximately 20.5 cm in attached pergolas and by 18.5 cm in freestanding ones. Posts are Ø 3 cm H 250 cm. Thus the wall height of the curved attached pergola is: 280 cm for models 135 cm deep; 290 cm for models 220 cm deep; 310 cm for models 320 cm deep. Fixing kit excluded.

Le misure riportate nei disegni si riferiscono agli ingombri massimi. Il decoro delle travi sporge rispetto ai pilastri di circa cm 20,5 nelle pergole addossate e di cm 18,5 in quelle autoportanti. I pilastri sono Ø cm 3 e H cm 250. La conseguente altezza a parete per le pergole addossate curve è di: cm 280 per il modello di profondità cm 135; cm 290 per il modello di profondità cm 220; cm 310 per il modello di profondità cm 320. Kit di fissaggio escluso.

Les mesures reportées dans les dessins se réfèrent aux encombrements maximums. La décoration des travers dépassent d'environ 20,5 cm par rapport aux piliers pour les pergolas adossées et de 18,5 cm pour les pergolas autoportantes. Les piliers ont un Ø de 3 cm et H 250 cm. La hauteur conséquente au mur pour les pergolas adossées courbées est de : 280 cm pour le modèle de 135 cm de profondeur ; 290 cm pour le modèle de 220 cm de profondeur ; 310 cm pour le modèle de 320 cm de profondeur. Kit de fixation exclu.

Fixed shades / Teli fissi / Toiles fixes

Kit for waterproof shade white (39% polyester coated with 61% PVC), complete with fixing components / Kit telo impermeabile bianco (poliestere 39% spalmato di PVC 61%), completo di elementi di fissaggio / Kit toile imperméable blanc (39% polyester enduit de 61% PVC), avec éléments de fixation

For curved attached pergola, 220 cm deep / Per pergola adossata curva, cm 220 di profondità Pour pergola adossée courbée, de 220 cm de profondeur	CO220
With 1 extension / Con 1 estensione / Avec 1 extension	CO220E1
With 2 extensions / Con 2 estensioni / Avec 2 extensions	CO220E2
For curved attached pergola, 320 cm deep / Per pergola adossata curva, cm 320 di profondità Pour pergola adossée courbée, de 320 cm de profondeur	CO320
With 1 extension / Con 1 estensione / Avec 1 extension	CO320E1
With 2 extensions / Con 2 estensioni / Avec 2 extensions	CO320E2
For curved freestanding pergola, 240 cm deep / Per pergola autoportante curva, cm 240 di profondità Pour pergola autoportante courbée, de 240 cm de profondeur	CO240
With 1 extension / Con 1 estensione / Avec 1 extension	CO240E1
With 2 extensions / Con 2 estensioni / Avec 2 extensions	CO240E2
For curved freestanding pergola, 340 cm deep / Per pergola autoportante curva, cm 340 di profondità Pour pergola autoportante courbée, de 340 cm de profondeur	CO340
With 1 extension / Con 1 estensione / Avec 1 extension	CO340E1
With 2 extensions / Con 2 estensioni / Avec 2 extensions	CO340E2

To order roofing for pergolas with more than two extensions, substitute the “2” of the relative code of the pergola with two extensions, with the actual number of extensions (CO220E3 -CO220E4) / Per ordinare coperture di pergole con più di 2 estensioni, sostituire il “2” nei codici relativi alle pergole con 2 estensioni con il numero di quelle previste (es. CO220E3 -CO220E4) / Pour commander les couvertures des pergolas ayant plus de 2 extensions, remplacer le “2” dans les codes relatifs aux pergolas avec 2 extensions, avec le numéro des pergolas désirées (ex. CO220E3 -CO220E4).

Bamboo shades / Stuoie di canne di bambù / Nattes en cannes de bambou

Kit for bamboo shades made with bamboo canes of varying diameter (from 1 cm to 2 cm each) connected with a stainless steel wire. The kit includes fitting components / Kit di stuoie realizzate con canne di bambù di sezione variabile (da cm 1 a cm 2 ca.) e unite da un filo passante di acciaio inox. I kit sono completi di elementi di fissaggio / Kit de nattes réalisées en cannes de bambou de section variant de 1 cm à 2 cm environ et reliées par un fil en acier inoxydable. Eléments de fixation compris dans le kit.

structure / strutture / structures	
PSA2EC - PSW2EC - PSP2EC - PSAP2EC	COBAM1
PSW2C - PSP2C - PSA2C - PSAP2C - PSW3EC - PSP3EC - PSA3EC - PSAP3EC - PSW3EC - PSP3EC PSA3EC - PSAP3EC	COBAM2
PSW3C - PSP3C - PSA3C - PSAP3C	COBAM3

Roll shades / Teli scorrevoli / Toiles coulissantes

Kit for adjustable shade in 100% acrylic, colour écru complete with powder coated aluminium casing, spring retractable mechanism with tracks, for attached pergolas and extensions / Kit telo regolabile di acrilico 100% colore écru, completo di coprirullo di alluminio verniciato a polveri, avvolgibile a molla e guide, per pergole adossate ed estensioni / Kit toile réglable en 100% acrylique couleur écru avec coffre pour rouleau en aluminium thermolaqué, enrouleur à ressort et glissières, pour pergolas adossées et extensions.

Structure / Strutture / Structures	
PSW2C	CORUS2
PSW2EC	CORUS2E
PSW3C	CORUS3
PSW3EC	CORUS3E
PSP2C	CORUSP2
PSP2EC	CORUSP2E
PSP3C	CORUSP3
PSP3EC	CORUSP3E

Kit for adjustable shade white (29% polyester coated with 71% PVC) complete with powder coated aluminium casing, graphite, spring retractable mechanism with tracks,for attached pergolas and extensions / Kit telo regolabile impermeabile bianco (poliestere 29% spalmato di PVC 71%), completo di coprirullo di alluminio verniciato a polveri grafite, avvolgibile a molla e guide, per pergole adossate ed estensioni / Kit toile réglable imperméable blanc (29% polyester enduit de 71% PVC), avec coffre pour rouleau en aluminium thermolaqué, enrouleur à ressort et glissières, pour pergolas adossées et extensions.

Structure / Strutture / Structures	
PSW2C	CORUS2PVC
PSW2EC	CORUS2EPVC
PSW3C	CORUS3PVC
PSW3EC	CORUS3EPVC

Panels in diamond pattern / Pannelli a maglia romboidale / Panneaux maille losange

Grilles in iron with 13 x 13 cm perforated pattern in sheet metal with folded edges (W x H) / Grigliati di ferro con maglia di cm 13 x 13 in lamiera forata e bordo ripiegato (L x H) / Treillages en fer à mailles de 13 x 13 en tôle perforée et bord plié (L x H)

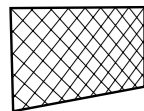

30 x 102	GRFR12
30 x 150	GRFR13
102 x 102	GRFR22
102 x 150	GRFR23
174 x 102	GRFR42

Panels in square pattern / Pannelli a maglia quadrata / Panneaux maille carrée

Grilles in iron 23.2 x 23.2 cm square pattern of crisscrossed iron rods within a frame (W x H) / Grigliati di ferro con maglia di cm 23,2 x 23,2 in tondini di ferro sovrapposti e racchiusi in un telaio (L x H) / Treillages maille carrée 23,2 x 23,2 en barres de fer superposés et montées sur châssis (L x H)

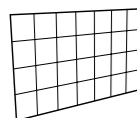

30 x 102	GRF12
30 x 150	GRF13
102 x 102	GRF22
102 x 150	GRF23
150 x 150	GRF33
174 x 102	GRF42
174 x 150	GRF43

Capping pieces / Elemento di coronamento / Couronnement

Components Ø 2 in iron to fix two posts, alone or with the relative grilles / Elementi Ø 2 di ferro da utilizzare tra due pilastri, da soli o con i grigliati corrispondenti / Éléments Ø 2 en fer à utiliser entre deux piliers, seuls ou avec les treillages correspondants.

Straight / Lineare / Linéaire	Length / Lunghezza / Longueur	
	39	COF1L
	111	COF2L
	159	COF3L
	183	COF4L
Curved / Curvilineo / Arqué	Length / Lunghezza / Longueur	
	111	COF2C
	159	COF3C
	183	COF4C

Posts H 75 / Pilastrini H 75 / Piliers H 75

Post Ø 3 H 75 in iron with fixing bracket, bracket cover and ball finial decoration / Pilastrino Ø 3 H 75 di ferro con staffa di fissaggio e copristaffa, decoro finale a sfera / Pilier Ø 3 H 75 en fer avec équerre pour fixation et cache pour équerre, boule d'ornement finale



*** Single with couplings for fixing grilles / *** Singolo con giunti per fissaggio grigliati / *** Simple avec joints pour fixation des treillages

PFS75C



Double with couplings for fixing grilles / Doppio con giunti per fissaggio grigliati / Double avec joints pour fixation des treillages

PFD75C

(*) Single posts, couplings excluded, used to fix capping pieces, while single posts with couplings are used for bridging and creating openings.
 (**) Components can be cut to size, according to the width of the gap to be bridged.
 (***) Each post is fixed to the parapet using brackets with 3 masonry plugs Ref. TFP or with chemical plugs Ref. TC6SP according to the nature of the parapet.
 (*) I pilastri singoli, giunti esclusi, si utilizzano per il fissaggio di elementi di coronamento, mentre per gli elementi di compensazione e affaccio si utilizzano pilastri singoli con giunti.
 (**) Gli elementi possono essere tagliati su misura, in funzione del perimetro da schermare.
 (***) Il fissaggio di ogni pilastro singolo sul parapetto per mezzo della staffa avviene con 3 tasselli ad espansione Art. TFP o con tasselli chimici Art. TC6SP, da scegliere a seconda della natura del parapetto.
 (*) Les piliers simples, sans joints, s'utilisent pour la fixation des éléments de couronnement tandis que pour les éléments de compensation et de raccords utiliser des piliers simples avec joints.
 (**) Les éléments peuvent être découpés sur mesure, en fonction du périmètre à clôturer.
 (***) La fixation de chaque pilier simple au parapet à l'aide d'une équerre est faite avec 3 chevilles à expansion Réf. TFP ou avec des chevilles chimiques Réf. TC6SP en fonction du type de parapet.

Posts H 260 / Pilastrini H 260 / Piliers H 260

Post Ø 3 H 260 in iron with ball finial decoration / Pilastrino Ø 3 H 260 di ferro con decoro finale a sfera / Piliers Ø 3 H 260 en fer avec boule d'ornement final



Single with couplings for fixing grilles / Singolo con giunti per fissaggio grigliati / Simple avec joints pour fixation des treillages

PFSG



* Double with couplings for fixing grilles / * Doppio con giunti per fissaggio grigliati / * Double avec joints pour fixation des treillages

PFDG



Single, couplings not included / Singolo, giunti esclusi / Simple, joints exclus

PFS

Bridge opening ** / Compensazione - Affaccio ** / Éléments de compensation - Raccords **

Components including 2 capitals and 1 connecting piece in iron to bridge a gap and create an entrance / Elementi composti da 2 capitelli e 1 profilo di giunzione di ferro per realizzare zone di compensazione e affaccio / Éléments composés de 2 chapiteaux et d'un profilé de jonction en fer pour réaliser des zones de compensations et de raccords



L 183

ECF183

L 262

ECF262

Fitting components / Fissaggi / Fixations

Bracket for fixing one post to the ground, complete with 3 plugs, Ø mm 10 / Staffa per fissaggio a terra di 1 pilastro, completa di 3 tasselli ad espansione, Ø mm 10 / Équerre pour fixer au sol 1 pilier, avec 3 chevilles à expansion Ø 10 mm

SAPS

Hardware kit for fixing one panel to posts / Kit ferramenta per il fissaggio di un pannello ai pilastri / Paire d'équerres pour fixation d'un pilier



EFP4

Pair of brackets for fixing post / Coppia di staffe per fissare il pilastro / Paire d'équerres pour fixation d'un pilier



To masonry parapet / Al parapetto in muratura / À un parapet en maçonnerie

SFP2



To iron railing / Alla ringhiera in ferro / À une balustrade en fer

SFR2



Aluminium coupling for iron post / Giunto di alluminio per pilastro in ferro / Joint en aluminium pour pilier en fer

G33NC

Pavilion / Padiglione / Gloriette

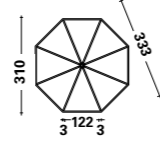
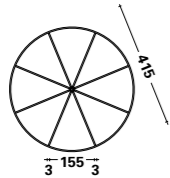

Ø 415 with 8 - round posts

octagonal side 122 (max Ø 333)

Pavilion round Ø 415 with 8 round posts Ø 3 H 250 in iron and galvanized steel wire / Rotondo Ø 415 con 8 pilastri rotondi Ø 3 di ferro e filo di acciaio zincato / Ronde Ø 415 avec 8 piliers ronds Ø 3 H 250 en fer et fil d'acier galvanisé

PATRR

Pavilion octagonal side 122 (max Ø 333) with 8 round posts Ø 3 H 250 in iron and galvanized steel wire / Padiglione ottagonale lato 122 (max Ø 333) con 8 pilastri rotondi Ø 3 H 250 di ferro e filo di acciaio zincato / Octogonale côté 122 cm (max Ø 333) avec 8 piliers ronds Ø 3 H 250 en fer et fil d'acier galvanisé

PATRO

Grilles 102 cm wide are suitable for octagonal pavilions, and grilles 150 cm wide for round pavilions.
 Fixing kit excluded
 Per il padiglione ottagonale sono adatti grigliati di larghezza cm 102; per il modello rotondo, grigliati di larghezza cm 150.
 Kit di fissaggio escluso
 Pour les gloriettes octogonales choisir les treillages de 102 cm de largeur; pour les gloriettes rondes choisir les treillages de 150 cm de largeur.
 Kit de fixation exclu.

Waterproof covers / Teli di copertura / Toile imperméables

Waterproof cover with fittings for pavilion
 Telo impermeabile con fissaggi
 Toile imperméable avec fixation

for round pavilion / per padiglione rotondo / pour gloriette ronde

TINTR

for octagonal pavilion / per padiglione ottagonale / pour gloriette octogonale

TINTO

Accessories / Accessori / Accessoires



Coupling in aluminium for fixing iron grilles to pavilion / Giunto in alluminio per il fissaggio dei grigliati in ferro ai padiglioni / Joint en aluminium pour fixation des treillages en fer aux gloriettes

G33NCT



Hardware kit in aluminium for fixing 1 square or diamond pattern metal grille to octagonal pavilion / Kit ferramenta in alluminio per il fissaggio di 1 grigliato in ferro sia a maglia quadrata che romboidale al padiglione ottagonale / Kit pièces en aluminium pour fixation d'un treillage en fer à mailles carrées ou losanges à la gloriette octogonale

EFP4TO



Hardware kit in aluminium for fixing 1 iron diamond patterned grille to round pavilion / Kit ferramenta in alluminio per il fissaggio di 1 grigliato in ferro a maglia romboidale al padiglione rotondo / Kit pièces en aluminium pour fixation d'un treillage en fer à la gloriette ronde à maille losange

EFP4TR

Hardware kit in aluminium for fixing 1 iron square patterned grille to octagonal pavilion / Kit ferramenta in alluminio per il fissaggio di 1 grigliato in ferro a maglia quadrata al padiglione rotondo / Kit pièces en aluminium pour fixation d'un treillage en fer à la gloriette ronde à maille carrée

EFPQ4TR

Bracket for fixing one post to the ground, complete with Ø 10 mm plugs / Staffa per fissaggio a terra di 1 pilastro, completa di 3 tasselli ad espansione Ø mm 10 / Équerre pour fixer au sol 1 pilier, avec 3 chevilles à expansion Ø 10 mm

SAPS

Planters / Fioriere / Jardinières

Wall-mounted / Adossate / Adossées

	37 x 42.5	FRS37
	42,5 x 42,5	FRS41
	109 x 42.5	FRS109
	157 x 42.5	FRS157
	181 x 42.5	FRS181

Freestanding / Autoportanti / Autoportantes

	45 x 45	FARS45
	109 x 45	FARS109
	157 x 45	FARS157
	181 x 45	FARS181

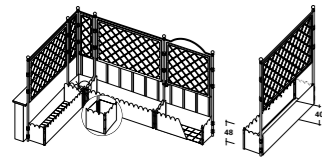

Wall-mounted Solaire planters must only be used with posts, grilles and the other accessories suggested on these and previous pages. 4 aluminium couplings Ref. G33NC, are necessary for fixing to posts, making the length of the planters 37, 109, 157 e 181 cm and respectively compatible with 30, 102, 150 e 174 cm grilles.

A 42.5 x 42.5 cm corner unit is also available.

Le fioriere Solaire adossate devono essere utilizzate esclusivamente con i pilastri, i grigliati e gli altri accessori proposti in queste e nelle precedenti pagine. Per fissarle ai pilastri sono necessari 4 giunti in alluminio Art. G33NC che rendono le fioriere di lunghezza cm 37, 109, 157 e 181 compatibili rispettivamente con i grigliati di cm 30, 102, 150 e 174. È disponibile una variante d'angolo di cm 42,5 x 42,5.

Les jardinières Solaire adossées doivent être utilisées exclusivement avec les piliers, les treillages et les autres accessoires proposés dans ces pages. Pour les fixer aux piliers utiliser 4 joints en aluminium Réf. G33NC, p. 214 rendant ainsi compatibles, respectivement, les jardinières de 37, 109, 157 et 181 cm de longueur avec les treillages de 30, 102, 150 et 174 cm. Un modèle d'angle de 42,5 x 42,5 cm est également disponible.

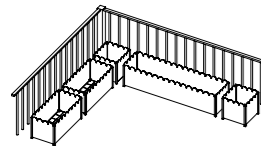

Freestanding planters can only be used as autonomous units and although compatible with items of the Collection, they cannot be affixed to them. Therefore they must be used as separate features or where grilles have already been installed.

Le fioriere Solaire autoportanti possono essere utilizzate solo come strutture autonome in quanto, pur essendo compatibili con gli elementi della collezione, non possono essere fissate ad essi. Devono essere quindi usate in modo indipendente o nel caso in cui i grigliati siano già stati fissati.

Les jardinières Solaire autoportantes peuvent être utilisées uniquement comme structures autonomes car bien qu'étant compatibles avec les éléments du Système, elles ne peuvent pas être fixées à ces dernières. Elles doivent donc être utilisées de façon indépendante ou dans le cas où les treillages aient déjà été fixés.

Finishes / Finiture / Finitions

 Powder coated galvanized iron graphite
Ferro zincato verniciato a polveri grafite
Fer galvanisé enduit de poudre graphite

 White PVC sheet
Telo bianco PVC
Tôle PVC blanche

 100% acrylic fabric in ecru
Tessuto acrilico 100% ecru
Tissu 100% acrylique écru

 Bamboo mat
Stuoia bambù
Natte de bambou

Tibisco

Tibisco reinterprets the historic structures found in ancient Cistercian monasteries, offering a line of pergolas in a classic, traditional style.

The romantic, ornamental style is conveyed by the circular patterns of the front beams, which interact harmoniously with the slim, delicate structure made from powder-coated galvanised iron.

IT Tibisco reinterpreta le storiche strutture presenti negli antichi monasteri cistercensi, proponendo una linea di pergole dallo stile classico e tradizionale. Il sapore romantico e ornamentale si distingue nei motivi circolari delle travi frontali, che dialogano armoniosamente con la struttura sottile e delicata in ferro zincato verniciato a polveri.

FR Tibisco réinterprète les structures historiques présentes dans les anciens monastères cisterciens et propose une ligne de pergolas au style classique et traditionnel. Le style romantique et ornemental se distingue par ses motifs circulaires des traves frontales qui complètent harmonieusement la structure fine et délicate en fer galvanisé peint revêtu de poudre.







Available as wall-mounted, free-standing or in the form of a pavilion, the collection can be embellished with decorations and semicircles in the bases, to add details of style and timeless elegance.

FREE STANDING

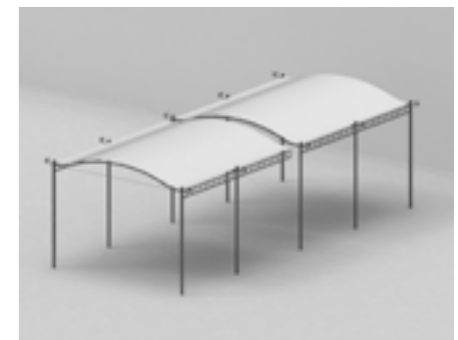
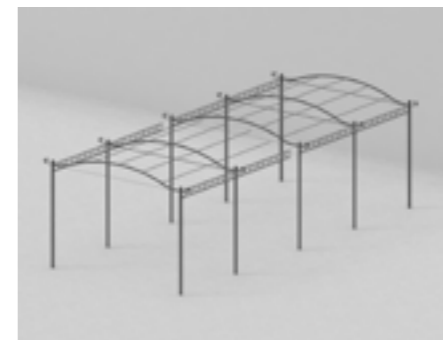
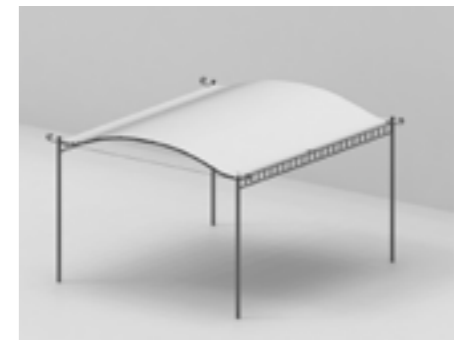
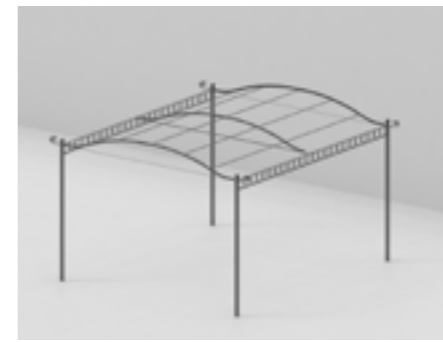

WALL-MOUNTED

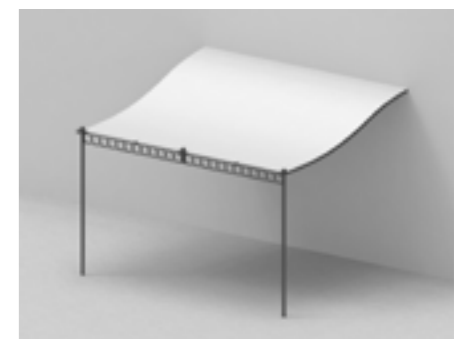

IT Disponibile addossata, autoportante e sottoforma di padiglione, la collezione può essere integrata con decori e semicerchi nei basamenti, per aggiungere dettagli di stile ed eleganza senza tempo.

FR Disponibles en version autoportante et adossée sous forme de pavillon, les pergolas de cette collection peuvent être complétées de décorations et de demi-cercles au niveau de la base pour ajouter des détails de style et d'élégance intemporelle.



Freestanding pergola without roofing* / Pergola autoportante senza copertura* / Pergola autoportante sans couverture*

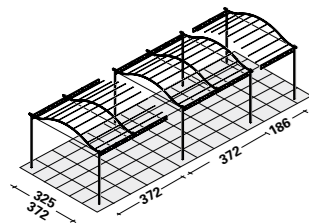

W 376 D 366 - 413

Pergola W 376 / Pergola / Pergola		Extension W 186 / Estensione / Extension		Extension W 372 / Estensione / Extension	
D 366	PEA366	D 366	EEA366	D 366	EEA366D
D 413	PEA413	D 413	EEA413	D 413	EEA413D

Fixing kit excluded / Kit di fissaggio escluso / kit de fixation exclu

Fixing kit excluded / Kit di fissaggio escluso / kit de fixation exclu

Wall-mounted pergola without roofing* / Pergola addossata senza copertura* / Pergola adossée sans couverture*

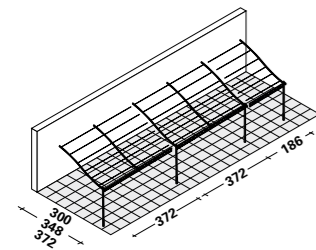

W 376 D 321 - 369 - 393

Pergola W 376 / Pergola / Pergola		Extension W 186 / Estensione / Extension		Extension W 372 / Estensione / Extension	
D 321	PE321	D 321	EE321	D 321	EE321D
D 369	PE369	D 369	EE369	D 369	EE369D
D 393	PE393	D 393	EE393	D 393	EE393D

Fixing kit excluded / Kit di fissaggio escluso / kit de fixation exclu

Maximum width to wall 385 cm. The relative measurements between posts are given in the technical illustration. The beam spirals overhang the posts by 18.5 cm.

L'ingombro totale a parete è di cm 385. Nei disegni sono riportate le misure di interesse tra i pilastri. Le volute delle travi sporgono di cm 18,5 rispetto ai pilastri.

L'encombrement total au mur est de 385 cm. Les mesures reportées dans les dessins sont les mesures entraxes des piliers. Les volutes des piliers dépassent de 18,5 cm par rapport aux piliers.

Wall-mounted pergola with polycarbonate roof** / Pergola addossata con copertura in polycarbonato** / Pergola adossée avec couverture en polycarbonate**

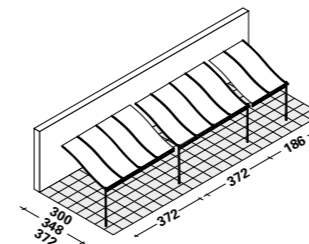

Maximum width to wall 385 cm.
L'ingombro totale a parete è di cm 385.
L'encombrement total au mur est de 385 cm.

W 376 D 321 - 369 - 393

Pergola W 376 / Pergola / Pergola		Extension W 186 / Estensione / Extension		Extension W 372 / Estensione / Extension	
D 321	PE321PC	D 321	EE321PC	D 321	EE321DPC
D 369	PE369PC	D 369	EE369PC	D 369	EE369DPC
D 393	PE393PC	D 393	EE393PC	D 393	EE393DPC

Fixing kit excluded / Kit di fissaggio escluso / kit de fixation exclu

*Freestanding pergolas have 4 x 4 cm posts H 280 which must be fixed to the ground, set in concrete to a depth of 40 cm

*Le pergole autoportanti hanno pilastri di cm 4 x 4 h cm 280 che devono essere fissati a terra, cementandoli, per circa cm 40.

*Les pergolas autoportantes ont des piliers de 4 x 4 cm h 280 cm qui doivent être fixés au sol dans à peu près 40 cm de ciment.

Pavilion / Padiglione / Gloriette

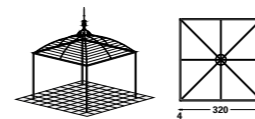

W 404 D 404 posts 4 x 4 H 280 / L 404 P 404 pilastri 4 x 4 H 280 / L 404 P 404 pilastri 4 x 4 H 280

Pavilion complete with 4 posts 4 x 4 H 280 / Padiglione completo di 4 pilastri 4 x 4 H 280 / Gloriette avec 4 piliers 4 x 4 H 280 PTD400

Waterproof cover / Telo impermeabile / Toile imperméable TPF400

Fixing kit excluded / Kit di fissaggio escluso / kit de fixation exclu

Bamboo shades / Stuoie di canne di bambù / Nattes en cannes de bambou

Kit for bamboo shades made with bamboo canes of varying diameter (from 1 cm to 2 cm each) connected with a stainless steel wire. The kit includes fitting components / Kit di stuoie realizzate con canne di bambù di sezione variabile (da cm 1 a cm 2 ca.) e unite da un filo passante di acciaio inox. I kit sono completi di elementi di fissaggio / Kit de nattes en cannes de bambou (de diamètre variant de 1 cm à 2 cm) reliées par un fil d'acier inoxydable. Eléments de fixations inclus dans le kit.

structure / strutture / structures

EE321 - EE369 - EE393 - EEA366 - EEA413	COBAM2
PE321 - EE321D - PE369 - EE369D PEA366 - EEA366D	COBAM3
PE393 - EE393D - PEA413 - EEA413D	COBAM4

Roll shades / Teli scorrevoli / Toiles coulissantes

Kit for adjustable shade in 100% acrylic, écru, complete with powder coated aluminium casing, colour graphite, spring retractable mechanism with tracks, for attached pergolas and extensions. / Kit telo regolabile di acrilico 100% colore écru, coprirullo di alluminio verniciato a polveri grafite, avvolgibile a molla e guide per pergole addossate ed estensioni. / Kit toile réglable 100% acrylique, couleur écru, coffre pour rouleau en aluminium thermolaqué, couleur graphite, enrouleur à ressort et glissières inclus, pour pergolas adossées et extensions.

structure / strutture / structures

PE321	CRE32
EE321	CRE32ES
EE321D	CRE32ED
PE369	CRE36
EE369	CRE36ES
EE369D	CRE36ED
PE393	CRE39
EE393	CRE39ES
EE393D	CRE39ED

Kit for adjustable shade waterproof white (29% polyester coated with 71% PVC), complete with powder coated aluminium casing, graphite, spring retractable mechanism with tracks, for attached pergolas and extensions. / Kit telo regolabile impermeabile bianco (poliestere 29% spalmato di PVC 71%), completo di coprirullo di alluminio verniciato a polveri grafite, avvolgibile a molla e guide, per pergole addossate ed estensioni. / Kit toile réglable imperméable blanche (29% polyester enduit de 71% PVC), coffre pour rouleau en aluminium thermolaqué, couleur graphite, enrouleur à ressort et glissières inclus, pour pergola adossées et extensions.

structure / strutture / structures

PE321	CRE32PVC
EE321	CRE32ESPVC
EE321D	CRE32EDPVC
PE369	CRE36PVC
EE369	CRE36ESPVC
EE369D	CRE36EDPVC
PE393	CRE39PVC
EE393	CRE39ESPVC
EE393D	CRE39EDPVC

Finishes / Finiture / Finitions

 Powder coated galvanized iron graphite
Ferro zincato verniciato a polveri grafite
Fer galvanisé enduit de poudre graphite

 Bamboo mat
Stuoia bambù
Natte de bambou

 White PVC sheet
Telo bianco PVC
Tôle PVC blanche

 100% acrylic fabric in ecru
Tessuto acrilico 100% ecru
Tissu 100% acrylique écru

Amanda

One of Unopiù's historic icons, Amanda is a hammock that expresses a timeless combination of comfort and design.

Its free-standing structure, made from walnut-coloured curved laminated wood, can be positioned as desired in any environment, transforming it into a personal space in which to indulge in relaxation.

IT Storica icona di Unopiù, Amanda è l'ama-
ca che esprime una combinazione senza tempo
di comfort e design.

La sua struttura auto portante in legno lamellare
curvato nelle tonalità del noce, può essere posi-
zionata a piacere in qualunque ambiente, trasfor-
mandolo in uno spazio personale in cui abband-
narsi al relax.

FR Icône historique d'Unopiù, Amanda est un
hamac confortable au style intemporel.

Sa structure autoportante en bois lamellé cintré
de couleur noyer peut être placée dans tout type
d'environnement pour créer des espaces person-
nalisés offrant une totale relaxation.







Two versions of the base are available: one made from wood, for a more classic solution, and one made from sandblasted galvanized steel, in a shapely and contemporary style.

IT Il basamento è disponibile in due versioni: in legno, per una soluzione più classica e in acciaio zincato sabbiato, dalle forme voluminose e dal gusto contemporaneo.

FR La base est disponible en deux version : en bois, pour une solution plus classique, et en acier galvanisé sablé aux formes volumineuses et de style contemporain.





M Amanda

- Treated lamellar wood / Legno lamellare impregnato / Bois lamellaire recourbé
- Natural galvanized steel / Acciaio galvanizzato naturale / Acier galvanisé naturel
- 100% cotton / Cotone grezzo / coton blanc
- Polypropylene / Polipropilene / Polypropylène

Hammock / Amaca / Hamac

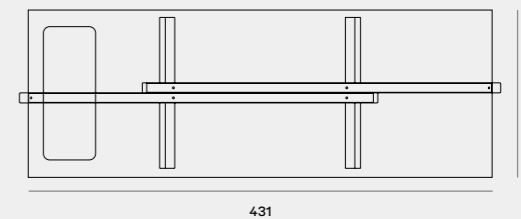
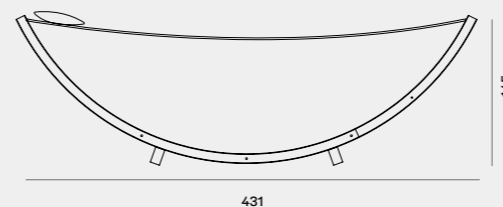

Wooden hammock / Amaca in legno / Hamac en bois

AMACA

100% cotton off white / cotone bianco naturale / Coton blanc
100% naturel

AMACAGM

Polypropylene grey mélange / Polipropilene grigio mélange /
Polypropylène gris chiné

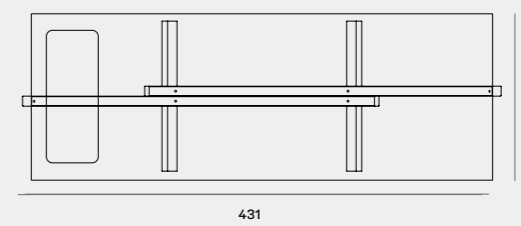
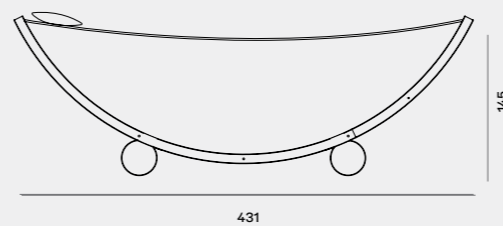

Galvanized steel hammock / Amaca in acciaio galvanizzato /
Hamac en acier galvanisé

AMACABF

Polypropylene grey mélange / Polipropilene grigio mélange /
Polypropylène gris chiné

Complements / Complementi / Compléments

Rete in corda di cotone bianco grezzo	Net 100% cotton off-white	Filet en corde de coton blanc écreu	RETE
Rete in corda in polipropilene grigio mélange	Net in grey mélange polypropilene	Filet de corde en polypropylène gris chiné	RETEGM
Cuscino in quarzo fumé	Cushion in quarzo fumé	Coussin quartz fumé	AMACACUSA002

Finishes / Finiture / Finitions

100% cotton off white
Cotone bianco naturale
Coton blanc 100% naturel

Polypropylene grey mélange
Polipropilene grigio mélange
Polypropylène gris chiné

Treated lamellar wood walnut
Legno lamellare impregnato tinto noce
Bois lamellé imprégné couleur noyer

Natural galvanized steel
Acciaio galvanizzato naturale
Acier galvanisé naturel

The woven rope net can be either white or in shades of grey and can accommodate up to two people.

Comfortable and ideal for a moment's relaxation, it establishes a harmonious dialogue with nature.

IT La rete dalla corda intrecciata può essere di colore bianco o grigio mélange e permette di ospitare fino a due persone.

Confortevole e ideale per prendersi un momento di relax, instaurando un armonioso dialogo con la natura.

FR Le filet en corde tressée est proposé en blanc ou gris chiné et permet d'accueillir jusqu'à deux personnes.

Confortable et idéal pour profiter d'une moment de détente, il instaure un harmonieux dialogue avec la nature.

Art of the Table

The collection includes dishware and glassware handcrafted by master glassmakers and potters, to set up and decorate your table in a classy, simple way.

IT La collezione comprende piatti e bicchieri realizzati artigianalmente da maestri del vetro e della ceramica, per allestire e decorare con eleganza e semplicità la tavola.

FR La collection comprend des assiettes et des verres fabriqués à la main par des maîtres du verre et de la céramique, pour dresser et décorer la table avec élégance et simplicité.





Table setting DEC1



Table setting DEC2

The hand painted earthenware dishware from Puglia are available in sets of three pieces. Matching salad bowls are available to set your table in style.



Table setting DEC3



Table setting DEC4



Table setting DEC5

Salad bowl DEC1



Salad bowl DEC2



Salad bowl DEC3



Salad bowl DEC4



IT I piatti realizzati in ceramica tradizionale cotta in forno e dipinta a mano in Puglia sono proposti in set da tre e si abbinano alle insalatiere, completare con stile la tavola.

FR Les assiettes en céramique traditionnelle cuite au four et peinte à la main dans les Pouilles sont proposées par lot de trois et, associées aux saladiers, complètent la table avec style.



The sophisticated rigadin torsè jug and glasses are hand-blown by master glass-makers, according to Murano traditions.

IT La brocca e i bicchieri in raffinato rigadin torsè sono soffiati a bocca da maestri vetrai impiegando la tradizionale lavorazione muranese.

FR La cruche et les verres en rigadin torsé raffiné sont soufflés à la bouche par des maîtres verriers selon le procédé traditionnel de Murano.

Art of the Table

- Handpainted ceramic / Ceramica dipinta a mano / Céramique peinte à la main
- Blown glass / Vetro soffiato / Verre soufflé

Ceramic set / Set ceramiche / Service en céramique

Ø 29 - 25 - 21

GRPTV1

Table setting DEC1 / Set tavola DEC1 /
Set de table DEC1

GRPTV2

Table setting DEC2 / Set tavola DEC2 /
Set de table DEC2

GRPTV3

Table setting DEC3 / Set tavola DEC3 /
Set de table DEC3

GRPTV4

table setting DEC4 / Set tavola DEC4 /
Set de table DEC4

GRPTV5

Table setting DEC5 / Set tavola DEC5 /
Set de table DEC5

GRPTV6

Table setting DEC6 / Set tavola DEC6 /
Set de table DEC6

Ø 36

GRINSV1

Salad bowl DEC1 / Insalatiera DEC1 /
Saladier DEC1

GRINSV2

Salad bowl DEC2 / Insalatiera DEC2 /
Saladier DEC2

GRINSV3

Salad bowl DEC3 / Insalatiera DEC3 /
Saladier DEC3

GRINSV4

salad bowl DEC4 / insalatiera DEC4 /
saladier DEC4

Glass set / Set vetro / Ensemble de verre

BI6RTAM Ø 7,5 H 9,5

Set of 6 glasses in turquoise /
Set 6 bicchieri vetro turchese /
Lot de 6 verres turquoises

BRORTAM Ø 7,5 H 24

Transparent glass jug /
Brocca trasparente /
Pichet en verre clair

POCA2RTAM Ø 13 H 15

Set of 2 candle holders in turquoise /
Set 2 portacandele vetro turchese /
Lot de 2 bougeoirs en verre turquoise

Aton

Designed by Marco Acerbis, Aton combines its simple shape with detail provided by the torsion of aluminium slats in the compositional process, which characterises all the lamps in the collection. The line is available in white and bronze colours and its discreet look makes it an ideal accessory both indoors and outdoors.

IT Disegnata da Marco Acerbis, Aton unisce alla sua forma semplice il dettaglio della torsione delle lamelle d'alluminio come lavorazione compositiva, che caratterizza tutte le lampade della collezione.

La linea è disponibile nelle tonalità del bianco e del bronzo, e il suo aspetto discreto la rende un accessorio ideale sia all'interno che all'esterno.

FR Conçue par Marco Acerbis, Aton offre une forme simple agrémentée de lames torsadées en aluminium, élément décoratif qui caractérise toutes les lampes de cette collection.

La ligne est disponible dans les tonalités blanc et bronze, et son aspect discret en fait un accessoire idéal à l'intérieur comme à l'extérieur.







The modern, sophisticated design of the shape comes to the fore when the light is switched on, as it delicately traverses the structure, transforming the environment into a warm, evocative landscape, full of shadows with delicate geometries.

IT Il design moderno e curato della forma diventa funzionale con l'accensione della fonte luminosa, che si propaga delicatamente attraverso la struttura, trasformando l'ambiente in un paesaggio caldo e suggestivo, in cui si disegnano ombre dalle delicate geometrie.

FR Présentant une forme moderne et soignée, le design devient fonctionnel lorsque la lampe est allumée, la source lumineuse se diffusant délicatement à travers la structure et transformant l'espace en un cadre chaleureux et suggestif où se dessinent des ombres aux motifs géométriques.

Aton

• Aluminum / Alluminio / Aluminium



Floor lamps / Lampade da terra / Lampadaire



ATAPB
White / Bianco / Blanc

ATAPBR
Bronze / Bronzo / Bronze



ATPIAB
White / Bianco / Blanc

ATPIA
Bronze / Bronzo / Bronze



ATPAB
White / Bianco / Blanc

ATPABR
Bronze / Bronzo / Bronze

Wall lamps / Lampade da parete / Appliques



ATAPMEB
White / Bianco / Blanc

ATAPMEBR
Bronze / Bronzo / Bronze



Finishes / Finiture / Finitions



Aluminum bronze
Alluminio bronzo
Aluminium bronze



Aluminum white
Alluminio bianco
Aluminium blanc

Barby

Modernity and technology are the characteristics of the three-burner stainless-steel barbecue designed by Andreucci & Hoisl.

Easy to move and use, it also has two lateral shelves that can be used for utensils during the preparation phase and becomes the ideal complement to make any occasion out in the open air enjoyable.

IT Modernità e tecnologia sono le peculiarità del barbecue a tre fuochi in acciaio inox, disegnato da Andreucci & Hoisl.

Di facile movimentazione ed utilizzo, si completa con due ripiani laterali, utili per appoggiare gli utensili in fase di preparazione, e diventa il complemento ideale per rendere conviviale ciascuna occasione all'aria aperta.

FR Modernité et technologie sont les caractéristiques de ce barbecue à trois feux en acier inoxydable conçu par Andreucci & Hoisl. Facile à déplacer et à utiliser, ce barbecue est doté de deux tablettes latérales qui permettent de poser les ustensiles en phase de préparation et devient un complément idéal lors de tous les moments de convivialité en plein air.





Barby features a fat-repellent cooking plate, ideal for cooking and subsequent cleaning and sanitation.

IT Barby è caratterizzato da una piastra di cottura grasso repellente, ideale per la cottura e la successiva pulizia ed igienizzazione.

FR Barby se distingue par une plaque de cuisson permettant de cuisiner sans gras, idéale pour optimiser la cuisson et pour faciliter l'entretien et l'hygiène.

Barby

- Powder coated galvanized iron / Ferro zincato verniciato a polveri / Fer galvanisé enduit de poudre
- Stainless steel / Acciaio inox / Acier inoxydable

Barbecue / Barbecue / Barbecue

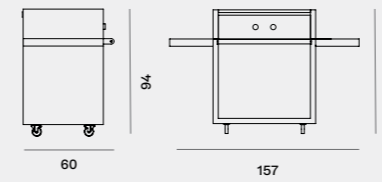



Barbecue / Barbecue / Barbecue
BBETIN

Complements / Complementi / Compléments

Stainless steel cylinder cover	Copribombola acciaio inox	Couvercle de cylindre en acier inoxydable	COBOET
Cooking grates	Griglia a lamelle	Grille de roseau	GRIETIN
Tool kit set	Set kit attrezzi	Trousse à outils	BBQSETIN

Finishes / Finiture / Finitions

-  Powder coated galvanized iron graphite
Ferro zincato verniciato a polveri grafite
Fer galvanisé enduit de poudre graphite
-  Stainless steel
Acciaio inox
Acier inoxydable

Capri

Colourful and comfortable, Capri is a collection of armchairs made from WaProLace® synthetic fibre, skilfully hand-woven by decorator craftsmen, with aluminium tubing.

It is practical, light and versatile, while the stone-washed fibre recreates an evocative atmosphere with a retro feel.

IT Colorata e confortevole, Capri è una collezione di poltroncine in fibra sintetica WaProLace®, sapientemente intrecciata a mano da artigiani decoratori, con tubolare in alluminio. È pratica, leggera e versatile, la fibra delavée ricrea una suggestiva atmosfera dal gusto rétro.

FR Colorée et confortable, Capri est une collection de fauteuils en fibre synthétique WaProLace® soigneusement tressée à la main par des artisans décorateurs à l'aide de tubes en aluminium. Pratique, légère et polyvalente, la fibre délavée crée une ambiance pittoresque au style rétro.

The model is available in a wide range of colours and the seats can be embellished by soft cushions with removable covers.

IT Il modello è disponibile in una vasta gamma cromatica, e le sedute possono essere integrate con morbidi cuscini sfoderabili.

FR Le modèle est disponible dans une vaste gamme chromatique, et les fauteuils peuvent être complétés de coussins déhoussables moelleux.







Capri

- Aluminum / Alluminio/ Aluminium
- WaProLace® synthetic fibre / Fibra sintetica WaProLace® / Fibre synthétique WaProLace®
- Removable cushions col standard Diamante 001 / Cuscini sfoderabili col. standard Diamante 001 / Coussins déhoussables col. standard Diamante 001

Sitting / Seduta / Assise

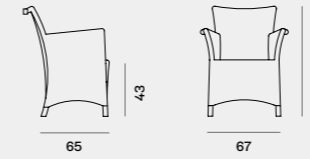

Small armchair / Poltroncina / Petit fauteuil

CPPOBLW

Blue / Blu / Bleu

CPPOCEW

Sky blue / Azzurro / Bleu clair

CPPOGIW

Yellow / Giallo / Jaune

CPPOPWR

Burgundy / Prugna / Prune

CPPOROW

Red / Rosso / Rouge

CPPOVEW

Green / Verde / Vert

CPCUPO

Cushion / Cuscino / Coussin

Finishes / Finiture / Finitions

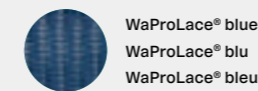

WaProLace® blue
WaProLace® blu
WaProLace® bleu



WaProLace® sky blue
WaProLace® azzurro
WaProLace® bleu clair



WaProLace® yellow
WaProLace® giallo
WaProLace® jaune



WaProLace® burgundy
WaProLace® prugna
WaProLace® prune



WaProLace® red
WaProLace® rosso
WaProLace® rouge



WaProLace® green
WaProLace® verde
WaProLace® vert



Removable cushions Masterline Colour Collection pg. 458
Cuscini sfoderabili Masterline Colour Collection pg. 458
Coussins déhoussables Masterline Colour Collection pg. 458

Carpets

Craftsmanship and sustainability blend to produce the Unopiù collection of rugs with clean designs and soft colour combinations, weaved using hand looms with polyester yarn that is produced from everyday recycled PET bottles.

IT Tra artigianalità e sostenibilità, nasce la collezione di tappeti Unopiù dal design pulito e dai tenui accostamenti cromatici, lavorati con telai a mano il cui filato di poliestere viene prodotto a partire dal riciclo delle comuni bottiglie di PET.

FR La collection de tapis Unopiù, de fabrication artisanale et durable, présente un design soigné et des combinaisons de couleurs subtiles. Les tapis sont tissés soigneusement à la main à partir de fil en polyester issu de bouteilles en PET recyclées.







Available in different sizes, these rugs become essential complements that complete and enrich the outdoor environment according to the various residential needs. The collection is available in three sets of colours: dove grey, grey and ocean.

IT Disponibili in diverse dimensioni, i tappeti diventano complementi immancabili per completare ed arricchire l'ambiente esterno in base alle varie esigenze abitative. La collezione è disponibile in tre colorazioni melangé: tortora, grigio e oceano.

FR Disponibles en diverses dimensions, ils deviennent des compléments indispensables pour compléter et enrichir l'environnement extérieur en fonction des différents besoins. La collection est disponible en trois coloris chinés : gris tourterelle, gris et océan.



Carpets

• Recycled PET / PET riciclato / PET recyclé

PET Carpets / Tappeti PET / PET Tapis

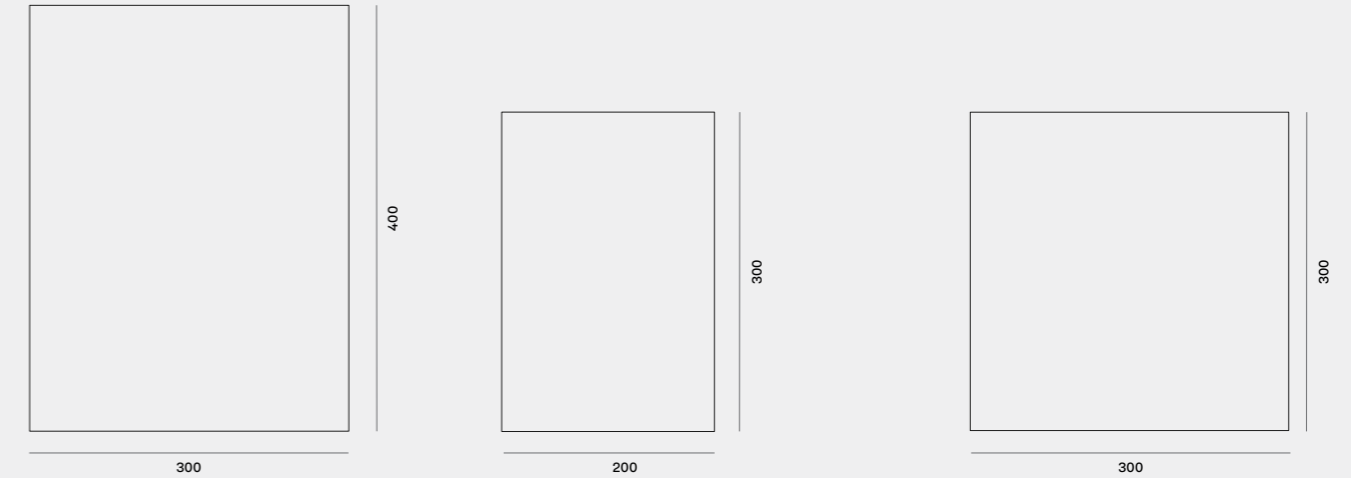

TAPETGRIS3X4
Dark gray / Grigio scuro / Gris foncé

TAPETBLBI3X4
Blue white / Blu/bianco / Bleu blanc

TAPETTOME3X4
Mélange dove gray / Tortora mélange / Gris tourterelle chiné

TAPETGRIS2x3
Dark gray / Grigio scuro / Gris foncé

TAPETBLBI2x3
Blue white / Blu/bianco / Bleu blanc

TAPETTOME2x3
Mélange dove gray / Tortora mélange / Gris tourterelle chiné

TAPETGRIS3x3
Dark gray / Grigio scuro / Gris foncé

TAPETBLBI3x3
Blue white / Blu/bianco / Bleu blanc

TAPETTOME3x3
Mélange dove gray / Tortora mélange / Gris tourterelle chiné

Finishes / Finiture / Finitions

 Recycled PET dark gray
PET riciclato grigio scuro
PET recyclé gris foncé

 Recycled PET mélange dove gray
PET riciclato tortora mélange
PET recyclé gris tourterelle chiné

 Recycled PET blue white
PET riciclato tortora blu bianco
PET recyclé bleu blanc

Hotty

Hotty is a collection of infrared aluminium heating lamps, created to make the outdoor environment comfortable even in the coldest weather.

IT Hotty è una collezione di lampade riscaldanti ad infrarossi in alluminio, pensate per rendere confortevole l'ambiente esterno anche nei periodi più freddi.

FR Hotty est une collection de lampes chauffantes à infrarouge en aluminium, spécialement conçues pour apporter plus de confort aux espaces extérieurs, même durant les périodes les plus froides de l'année.





Featuring a discreet, functional design, the cylindrical aluminium structure and the powder-coated galvanised iron base are available in floor and pendant versions, a practical solution that can be installed on existing supports. Resistant to humidity and with a high thermal output, they can be mechanically tilted from 25° to 45° to direct heat according to needs.

IT Dal design discreto e funzionale, la struttura cilindrica in alluminio e la base in ferro zincato verniciato a polveri sono disponibili nella versione a terra e a sospensione, pratica soluzione da installare a piacere su supporti esistenti. Resistenti all'umidità e dall'elevata resa termica, si possono inclinare meccanicamente da 25° a 45°, per direzionare il calore a seconda delle esigenze.

FR Présentant un design discret et fonctionnel, la structure cylindrique en aluminium et la base en fer galvanisé revêtu de poudre sont proposés dans la version lampadaire ou suspension, une solution pratique à installer à votre convenance sur des supports existants. Résistantes à l'humidité et offrant une puissance thermique élevée, elle peuvent s'incliner mécaniquement de 25° à 45° afin d'orienter la chaleur en fonction des besoins.

Hotty

- Aluminum / Alluminio / Aluminium
- Stainless steel / Acciaio inox / Acier inoxydable



Heat Lamp / Lampada solare / Lampe chauffante

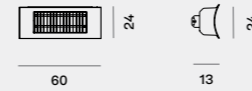

APPRIBI

White / Bianco / Blanc

APPRINE

Graphite / Grafite / Graphite

Standing Lamp / Piantana / Structure lampadaire



Standing Lamp / Piantana / Structure lampadaire

PIAPPRIBI

White / Bianco / Blanc

PIAPPRINE

Graphite / Grafite / Graphite

Complements / Complementi / Compléments

Telecomando

Remote controller

télécommande

TEAPPRI

Finishes / Finiture / Finitions

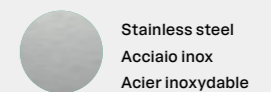
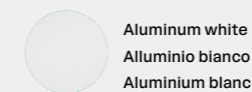
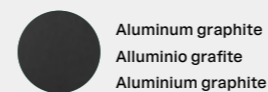

Jolly Cushions

Jolly cushions, available in various sizes, are essential to enriching and completing all Unopiù collections with elegance and harmony. Functionality and aesthetics nevertheless allow the linings to be removed for proper maintenance and customised in the various shades of the Unopiù colour collection.

IT I cuscini Jolly, disponibili in diversi formati, sono indispensabili per arricchire e completare con eleganza ed armonia tutte le collezioni Unopiù. Funzionalità ed estetica si distinguono nella possibilità di sfoderarli per permetterne la corretta manutenzione, e personalizzarli nelle diverse cromie della Colour Collection Unopiù.

FR Les coussins Jolly, disponibles en divers formats, sont indispensables pour enrichir et compléter avec élégance et harmonie toutes les collections Unopiù. À la fois esthétiques et fonctionnels, ils sont déhoussables, ce qui facilite leur entretien et permet de les personnaliser grâce à la vaste palette de coloris de la Colour Collection Unopiù.





The use of mass-dyed technical fabrics, which are very resistant to wear and UV rays, also make the cushions perfect for indoor solutions, thanks to innovative finishing techniques that ensure the colours do not fade over time.

IT L'utilizzo di tessuti tecnici tinti in massa, dall'alta resistenza all'usura ed i raggi UV, rendono i cuscini perfetti anche per soluzioni indoor, grazie agli innovativi trattamenti di finissaggio che garantiscono il mantenimento dei colori inalterato nel tempo.

FR L'utilisation de tissus techniques teintés dans la masse, hautement résistants à l'usure et aux rayons UV, rend ces coussins parfaits également pour le mobilier d'intérieur, grâce au traitement innovant de finition qui garantit la conservation des couleurs au fil du temps.

Jolly Cushions

• Removable cushion / Cuscini sfoderabili / Coussin déhoussable

Cushions / Cuscini / Coussins

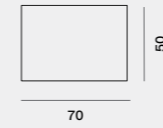

Removable cushion Cuscini sfoderabili / Coussin déhoussable **DECUR**

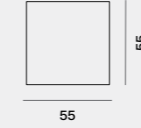

Removable cushion / Cuscini sfoderabili / Coussin déhoussable **DECUG**

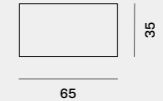

Removable cushion / Cuscini sfoderabili / Coussin déhoussable **DECURP**

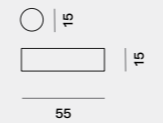

Removable cushion / Cuscini sfoderabili / Coussin déhoussable **DECIL**

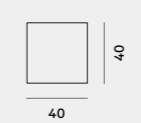

Removable cushion / Cuscini sfoderabili / Coussin déhoussable **DEJO**

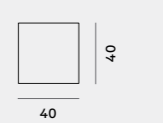

Removable cushion / Cuscini sfoderabili / Coussin déhoussable **DECUP**

Finishes / Finiture / Finitions



Removable cushions Masterline Colour Collection pg. 458
 Cuscini sfoderabili Masterline Colour Collection pg. 458
 Coussins déhoussables Masterline Colour Collection pg. 458

Solar Shower

Solar Shower is based on the idea of a shower as a personal space that should be enjoyed outdoors, in complete harmony with the natural landscape. Its mobility guarantees its installation anywhere, according to needs.

Hot Ball is the technological and sustainable solution that completes it, a collector of up to 40 litres of water that heats it by using solar energy, thereby ensuring the utmost comfort at all times.

IT Solar Shower nasce dall'idea di immaginare la doccia come uno spazio personale da godersi all'aria aperta, in totale armonia con il paesaggio naturale. La sua mobilità garantisce la possibilità di installarla a piacere, a seconda delle esigenze. Hot Ball è la soluzione tecnologica e sostenibile che la completa, collettore che raccoglie sino a 40 litri d'acqua e la riscalda grazie all'energia solare, garantendo così il massimo comfort in ciascun momento.

FR Avec Solar Shower, la douche est conçue comme un espace personnel dont on peut profiter en plein air et en totale harmonie avec le cadre naturel. Sa mobilité permet de l'installer à votre convenance, en fonction des besoins.

La douche est accompagnée du capteur solaire Hot Ball, une solution technologique durable d'une capacité allant jusqu'à 40 litres d'eau. L'eau est chauffée grâce à l'énergie solaire, pour offrir à tout moment un confort optimal.





The large 250 mm shower head guarantees a wide, pleasant jet, which can be adjusted using the mixer and is held by a polyethylene support. The base, made from precious Okumè wood, adds an elegant, sophisticated touch to the product.

The Hot Ball collector, with a capacity of 40 litres, can be installed both on a roof or on the ground. Its composition of mass-dyed graphite-coloured resin and aluminium guarantees excellent resistance to impacts and wear caused by atmospheric agents. The water can be heated using both electricity and solar energy.

IT L'ampio soffione di 250 mm garantisce un getto diffuso e piacevole, regolabile dal miscelatore ed è sorretto da un sostegno in polietilene. Il basamento in pregiato legno di Okumè aggiunge un dettaglio elegante e sofisticato al prodotto.

Il collettore Hot Ball, con una capienza di 40 litri, può essere installato a piacere sia su un tetto che a terra. La sua composizione in resina color grafite tinta in massa e alluminio garantisce un'ottima resistenza agli urti e all'usura da agenti atmosferici. L'acqua può essere riscaldata sfruttando sia l'elettricità che l'energia solare.

FR Le grand pommeau de douche de 250 mm garantit un jet large et agréable. Réglable à partir du mélangeur, il est soutenu par un support en polyéthylène. La base en bois précieux d'Okoumé apporte une touche élégante et raffinée au produit.

Le capteur solaire Hot Ball, d'une capacité de 40 litres, peut être installé sur un toit ou sur le sol. Sa composition en résine de couleur graphite teinte dans la masse garantit une résistance optimale aux chocs et à l'usure due aux agents atmosphériques. L'eau peut être chauffée à l'aide de l'énergie électrique ou solaire.

Solar Shower

- Black resin / Resina nera / Résine noire
- Aluminum / Alluminio / Aluminium
- Okumè wood / Legno di okumè / Bois d'okumè

Shower / Doccia / Douche

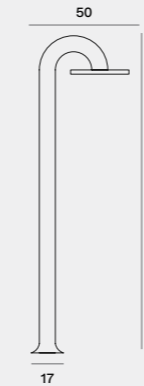

Solar Shower / Doccia solare / Douche solaire
DOFUN



Hot ball / Hot ball / Hot ball capteur solaire
HOBADOFUN

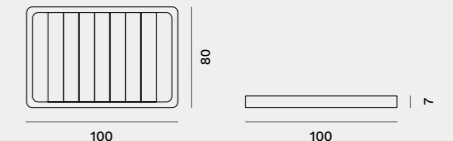

Shower tray / Piatto doccia / Receveur de douche
PIADOFUN

Finishes / Finiture / Finitions

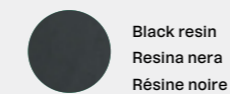

Black resin
Resina nera
Résine noire

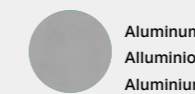

Aluminum
Alluminio
Aluminium

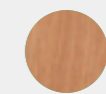

Okumè wood
Legno di okumè
Bois d'okumè

M Solare

Solare is a collection of lamps and lanterns where the versatility of the lines is expressed through materials, colours and shapes designed to respond to various functional and aesthetic needs.

All the models share the same light source: an LED solar panel integrated into the structure that is rechargeable and adjustable in terms of intensity and diffuses an intense light that transforms any room into a warm, domestic landscape.

IT Solare è una collezione di lampade e lanterne dove la versatilità delle linee si esprime attraverso materiali, colori e forme immaginate per rispondere a diverse esigenze funzionali ed estetiche.

Ciò che unisce tutti i modelli è la fonte luminosa: il led a pannelli solari integrato nella struttura, ricaricabile e regolabile nell'intensità, diffonde una luce intensa che trasforma ciascun ambiente in un caldo paesaggio domestico.

FR Solare est une gamme de lampes et de lanternes présentant une grande variété de lignes à travers les matériaux, les couleurs et les formes, conçus pour répondre à diverses exigences fonctionnelles et esthétiques.

Le point commun de tous ces modèles est la source lumineuse : le panneau solaire LED intégré à la structure, rechargeable et à l'intensité réglable, diffuse une lumière intense qui transforme tous les lieux en un cadre chaleureux et intime.

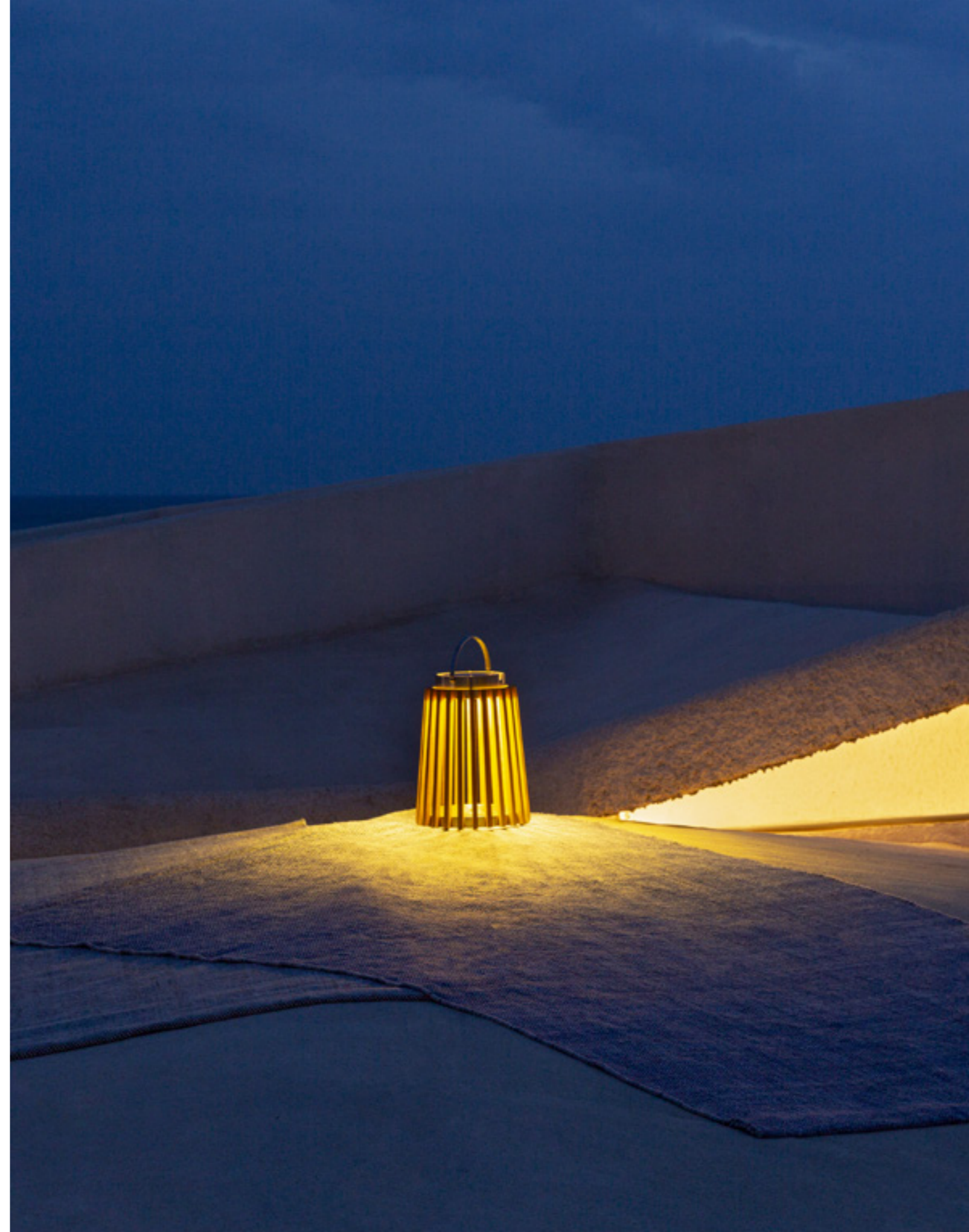





The collection includes elements of various heights and sizes, available in teak and synthetic rope, while the colour of the base can also be customised.

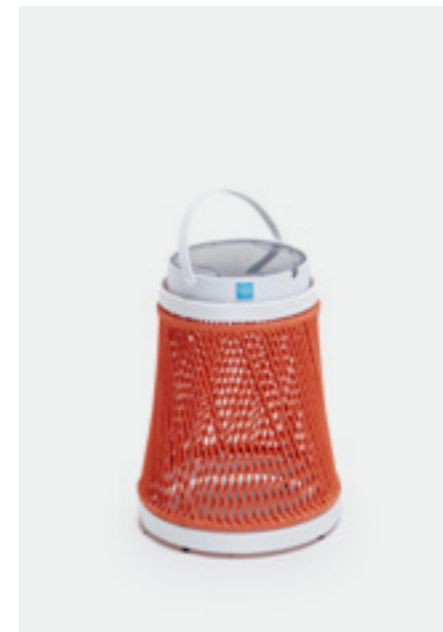
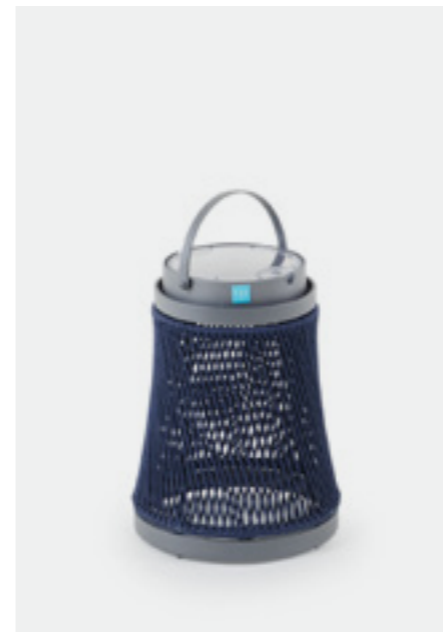

IT La collezione include elementi di altezze e misure diverse, disponibili in teak e corda sintetica, personalizzabili anche nel colore del basamento.

FR Cette collection comprend des éléments de hauteurs et de dimensions variées, disponibles en teck et corde synthétique, personnalisables également au niveau de la couleur de la base.

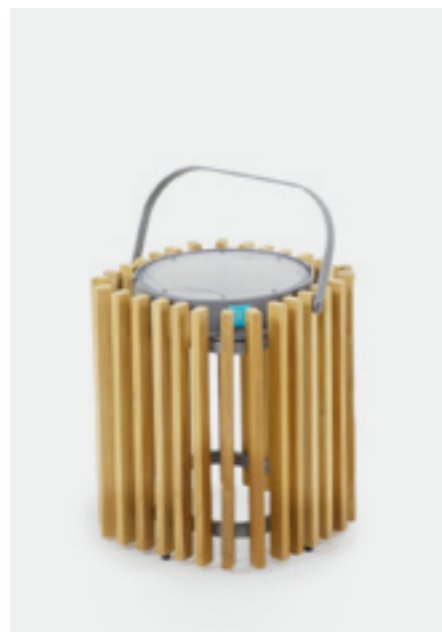
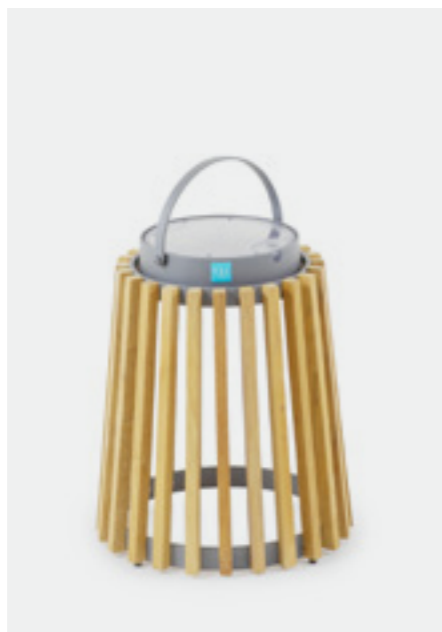

- Teak slats / Listelli di Teak / Lattes de teck
- Aluminum / Alluminio / Aluminium
- Polyolefin cord / Corda poliolefinica / Corde en polyoléfine
- LED 1320mAh - 2700k - 600 lm

Lanterns / Lanterne / Lanternes



Aluminum and teak/Alluminio e teak/ Aluminium et teck

LANATEBA

Teak + aluminium graphite/
Teak alluminio grafite/ Teck + aluminium graphite

LANITEBA

Teak + Stainless steel/ Teak + Acciaio inox / Teck + Acier inoxydable



Aluminum and cord/Alluminio e corda/ Aluminium et corde

LANSOBI1

White cord salmon/ Bianco corda salmone/ Blanc corde salmon

LANSOBI2

White cord blue/ Bianco corda blu / Blanc corde bleu

LANSOGR1

Graphite cord blue/ Grafite corda blu/ Graphite corde bleu

LANSOGR2

Graphite cord mustard/Grafite corda mostarda/ Graphite corde moutarde



Aluminum and teak/Alluminio e teak/ Aluminium et teck

LANTEQU

Teak + aluminium graphite/
Teak alluminio grafite/ Teck + aluminium graphite

Floor lamps / Piantane / Lampadaires



Aluminum and teak/Alluminio e teak/ Aluminium et teck

PITEAL

Teak + aluminium graphite/
Teak alluminio grafite/ Teck + aluminium graphite

PITEIN

Teak + Stainless steel/ Teak + Acciaio inox/ Teck + Acier inoxydable

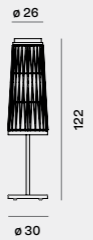

Aluminum and cord/Alluminio e corda/ Aluminium et corde

PIASOBI1

White cord salmon/ bianco corda salmone/ Blanc corde salmon

PIASOBI2

White cord blue/ bianco corda blu/ Blanc corde bleu

PIASOGR1

Graphite cord blue/ Grafite corda blu/ Graphite corde bleu

PIASOGR2

Graphite cord mustard/Grafite corda mostarda/ Graphite corde moutarde



Aluminum and teak/Alluminio e teak/ Aluminium et teck

PIANTEQU

Graphite/ Grafite/ Graphite

- Teak slats/ Listelli di Teak / Lattes de teck
- Aluminum/ Alluminio / Aluminium
- Polyolefin cord/ Corda poliolefinica / Corde en polyoléfine
- LED 1320mAh - 2700k - 600 lm



Complements / Complementi / Compléments

Graphite aluminum base	Base in alluminio grafite	Base en aluminium graphite	PIELA30FE
White aluminum base	Base in alluminio bianco	Base en aluminium blanc	PIELA30FEB
Stainless steel base	Base in acciaio inox	Base en acier inoxydable	PIELA30IN
Spike in stainless steel	Picca in acciaio inox	Pique en i acier inoxydable	PICPIASO
Bracket for anchoring to cement	Staffa per ancoraggio al cemento	Support pour ancrage au béton	PIECESO

Finishes / Finiture / Finitions



Aluminum graphite
Alluminio grafite
Aluminium graphite



Stainless steel
Acciaio inox
Acier inoxydable



Aluminum white
Alluminio bianco
Aluminium blanc



Polyolefin cord blue
Corda poliolefinica blu
Corde en polyoléfine bleu



Polyolefin cord salmon
Corda poliolefinica salmone
Corde en polyoléfine salmon



Polyolefin cord mustard
Corda poliolefinica mostarda
Corde en polyoléfine moutarde



Teak slats
Listelli di Teak
Lattes de Teck

Urbn Balcony

Urbn Balcony, designed by Meneghello Paoelli Associati, is a modular, versatile and modular system with a new vision for urban living, allowing the creation of many different furnishing solutions to enhance the potential of city balconies and terraces, thereby improving their enjoyment. Receiving a German Design Award 2021 'Special Mention' in the Excellent Product Design - Supplies category, the system can be used to configure small environments, in particular, creating sophisticated outdoor rooms that can be enjoyed all year round.

IT Urbn Balcony, disegnato da Meneghello Paoelli Associati, è un sistema modulare, versatile e componibile, che interpreta l'abitare urbano con una nuova visione, consentendo di realizzare molteplici soluzioni di arredamento per esaltare la potenzialità dei balconi e terrazzi cittadini, migliorandone la fruizione. Premiato dal German Design Award 2021 con una 'Special Mention' nella categoria Excellent Product Design - Forniture, è il sistema adatto a configurare soprattutto gli ambienti di piccole dimensioni, creando ricercate stanze all'aperto da vivere tutto l'anno.

FR Urbn Balcony, conçu par Meneghello Paoelli Associati, est un système modulaire et polyvalent qui revisite la vision de l'habitation urbaine. Il permet de réaliser de multiples solutions d'aménagement qui valorisent le potentiel des balcons et terrasses urbains et en améliorent l'utilisation. Récompensé par une Mention Spéciale aux German Design Awards 2021 dans la catégorie Produit Design – Fournitures d'Excellence, ce système est particulièrement adapté aux environnements de petites dimensions, créant des espaces extérieurs raffinés où se détendre toute l'année.







The structure, made from sophisticated, durable iroko wood, can be attached to the wall or ceiling and is completed by a series of accessories made from white aluminium, including vases and shelves, which can be configured as desired.

IT La struttura, in raffinato e resistente legno iroko, si può fissare a parete o soffitto e si completa con una serie di accessori in alluminio bianco, tra cui vasi e mensole, configurabili a proprio piacimento.

FR La structure en bois d'iroko raffiné et résistant peut se fixer au mur ou au plafond. Elle peut être complétée d'accessoires en aluminium blanc, entre autres des vases et des étagères configurables selon ses désirs.

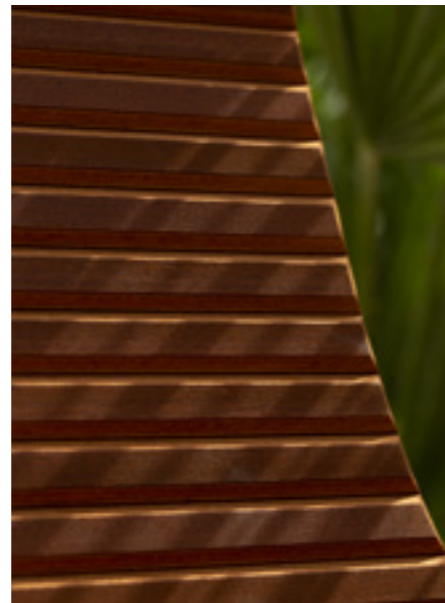



The table and seat, which feature a discreet and innovative design, exploit the technology of Wood-Skin® wooden fabric and can be folded away, allowing the furniture to be stored while maintaining the look and feel of the natural material par excellence.

IT Il tavolo e la seduta dal design discreto ed innovativo, sfruttano la tecnologia del tessuto ligneo Wood-Skin®, capace di piegarsi consentendo di riporre gli arredi mantenendo il gusto e l'estetica del materiale naturale per eccellenza.

FR La table et le siège au design discret et innovateur sont composés de tissu en bois Wood-Skin®, qui a la particularité de pouvoir se plier, ce qui permet de ranger les meubles tout en préservant la beauté de ce matériau naturel par excellence.

The Tripolina folding chair, whose practicality is reminiscent of camping furniture, is embellished by a central ring that is both decorative and, at the same time, renders the seat sturdy.

IT La tripolina, ispirata all'arredo da campeggio per la sua funzionalità, è impreziosita da un anello centrale che decora e allo stesso tempo rende la seduta robusta.

FR La chaise pliante, inspirée des meubles de camping pour sa fonctionnalité, est agrémentée d'un anneau central qui décore et, en même temps, rend le siège plus solide.

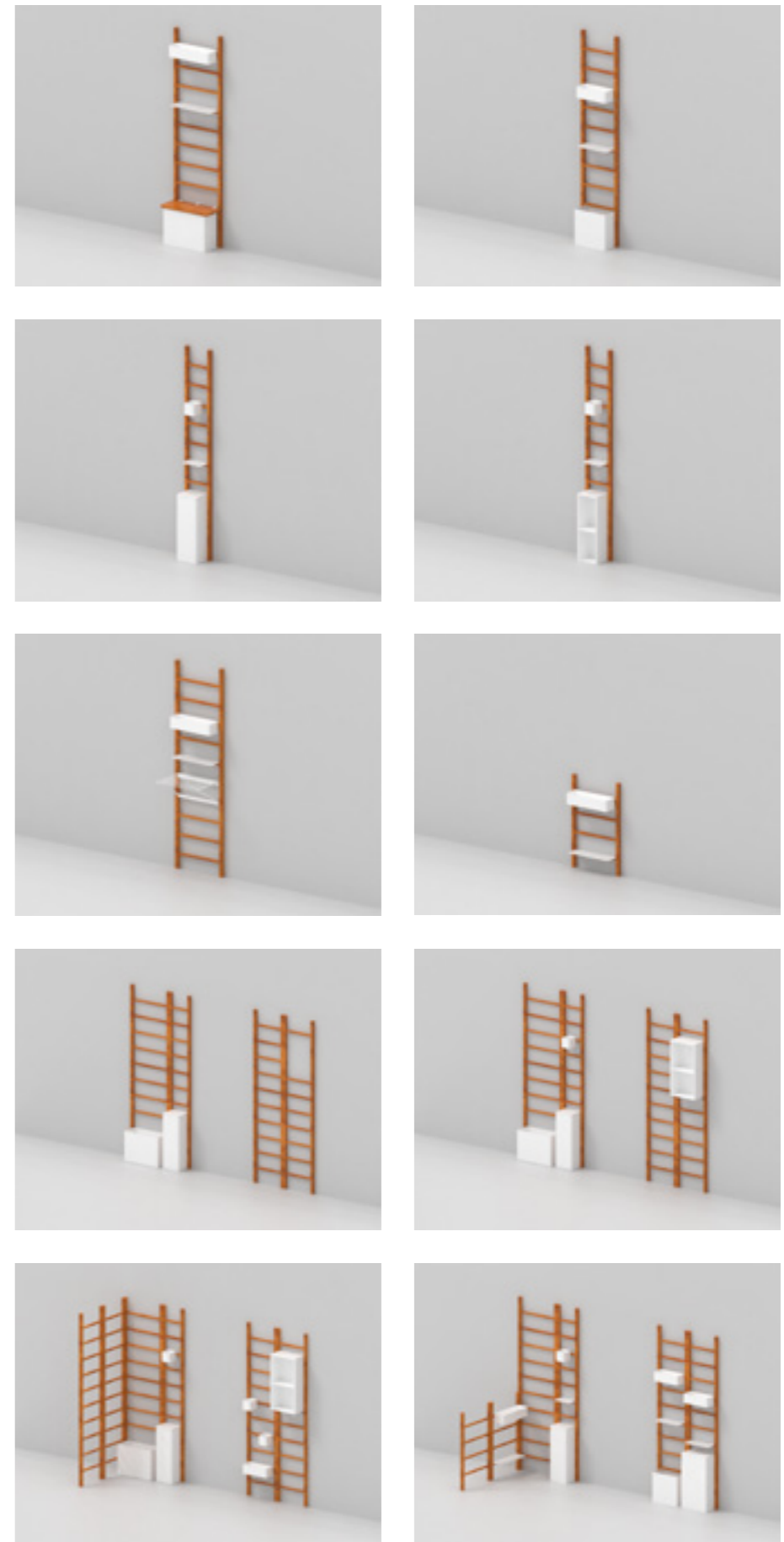

Urbn Balcony

- Iroko wood / Iroko / Bois d'iroko
- Teak / Teak / Teck
- Wood- Skin / Wood - Skin / Wood - Skin
- Steel/ Acciaio / Acier
- Aluminum / Alluminio / Aluminium

Chair - Table / Sedute - Tavoli / Chaises - Tables

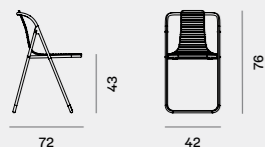

Small armchair folding / Poltroncina pieghevole / Petit fauteuil pliant

UBSED

white steel and Wood-Skin / acciaio bianco e Wood-Skin / fer couleur blanc et Wood-Skin

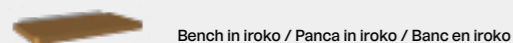

Table folding / Tavolo pieghevole / Table pliante allongeable

UBTAV

white steel and Wood-Skin / acciaio bianco e Wood-Skin / fer couleur blanc et Wood-Skin

Benches / Panche / Bancs



Bench in iroko / Panca in iroko / Banc en iroko

W 37 D 30 H 3	UBPAN29
W 53 D 30 H 3	UBPAN45
W 69 D 30 H 3	UBPAN61

Planters / Fioriere / Jardinières



Planter in aluminium / Fioriera in alluminio / Jardinière en aluminium

W 29 D 25 H 44	UBFIO29
W 45 D 25 H 44	UBFIO45
W 61 D 25 H 44	UBFIO61

Greenhouses / Fioriere / Jardinières



Greenhouse in white aluminium / Serra in alluminio bianco / Serre en aluminium blanc

W 29 D 25 H 84	UBSER29
W 45 D 25 H 84	UBSER45
W 61 D 25 H 84	UBSER61

Small cupboards / Armadietti / Armoires



Small cupboards / Armadietti / Armoires

W 29 D 25 H 84	UBARM29
W 45 D 25 H 84	UBARM45
W 61 D 25 H 84	UBARM61

Urbn Balcony

- Iroko wood / Iroko / Bois d'iroko
- Teak / Teak / Teck
- Wood- Skin / Wood - Skin / Wood - Skin
- Steel/ Acciaio / Acier
- Aluminum / Alluminio / Aluminium

Ladders / Scale / Échelles



Ladder in iroko with 10 rungs / Scala in iroko a 10 pioli / Échelle décorative en iroko avec 10 barreaux	W 37 D 4 H 265	UBSCA37
Ladder in iroko for railings / Scala in iroko per ringhiera / Échelle décorative en iroko pour rambarde	W 37 D 4 H 117	UBSCA37125
Ladder in iroko with 10 rungs / Scala in iroko a 10 pioli / Échelle décorative en iroko avec 10 barreaux	W 53 D 4 H 265	UBSCA53
Ladder in iroko for railings / Scala in iroko per ringhiera / Échelle décorative en iroko pour rambarde	W 53 D 4 H 117	UBSCA53125
Ladder in iroko with 10 rungs / Scala in iroko a 10 pioli / Échelle décorative en iroko avec 10 barreaux	W 69 D 4 H 265	UBSCA69
Ladder in iroko for railings / Scala in iroko per ringhiera / Échelle décorative en iroko pour rambarde	W 69 D 4 H 117	UBSCA69125
Fixing kit included / Kit di fissaggio incluso / kit de fixation inclus		

Accessories / Complementi / Compléments

Tray in white aluminium / Vassoio in alluminio bianco / Plateau en aluminium blanc	W 28 D 18	UBVASP
	W 44 D 18	UBVASM
	W 60 D 18	UBVASG
Pot in white aluminium / Vaso in alluminio bianco / Pot en aluminium blanc	W 28 D 18 H 14	UBVASOP
	W 44 D 18 H 14	UBVASOM
	W 60 D 18 H 14	UBVASOG
Clothesline in white aluminium / Stendino in alluminio bianco / Étendoir à linge en aluminium blanc	W 56 D 60	UBSTEND
Clothesline cover in white aluminium / Top per stendino in alluminio bianco / Couvercle de protection en aluminium blanc	W 50 D 56	UBTAVPI
"Tripolina" in teak / Tripolina in teak / Fauteuil Tripolina en teck	W40 D 40 H 40	UBTRIAL

Finishes / Finiture / Finitions

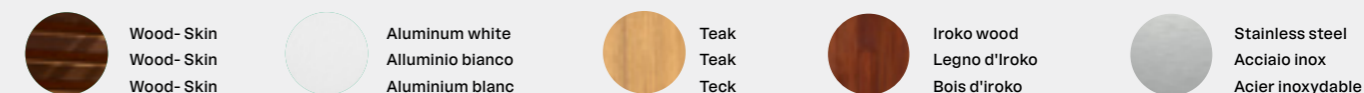

Vases

Essential accessories to complete the outdoors, Unopiù vases are characterised by discreet shapes and classic colours, so that the surrounding environment may be decorated without sacrificing style.

IT Complementi immancabili per completare l'outdoor, i vasi Unopiù sono caratterizzati da forme discrete e colori classici, per permettere di corredare l'ambiente che li ospita senza rinunciare allo stile.

FR Éléments incontournables pour compléter les espaces extérieurs, les vases Unopiù se caractérisent par leurs formes discrètes et leurs couleurs classiques, qui permettent de les coordonner à l'environnement sans renoncer au style.





The collection ranges from hand-worked, glazed stoneware models and classic, geometric planters, made using a mixture of concrete and crushed stone reinforced with natural fibres.

IT La collezione spazia da modelli in grès lavorati e smaltati a mano, e fioriere classiche e geometriche, realizzate con una miscela in cemento e pietrisco rinforzata con fibre naturali.

FR La collection propose des modèles en grès modelés et émaillés à la main ainsi que des jardinières classiques et géométriques réalisées à partir d'un mélange de béton et de pierres concassées renforcé avec des fibres naturelles.

Vases

- Glazed stoneware / Gres smaltato / Grès émaillé
- Concrete / Cemento / Béton

Glazed stoneware vases / Vasi smaltati in grès / Vases en grès émaillé

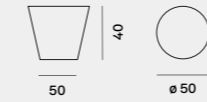

kg 23

VAG4050PR

Burgundy / Prugna / Prune

VAG4050GI

Yellow / Giallo / Jaune

VAG4050VO

Olive green / Verde oliva /
Olive vert

VAG4050BL

Blue / Blu / Bleu



kg 12

VAG3040PR

Burgundy / Prugna / Prune

VAG3040GI

Yellow / Giallo / Jaune

VAG3040VO

Olive green / Verde oliva /
Olive vert

VAG3040BL

Blue / Blu / Bleu

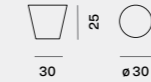

kg 7

VAG2530PR

Burgundy / Prugna / Prune

VAG2530GI

Yellow / Giallo / Jaune

VAG2530VO

Olive green / Verde oliva /
Olive vert

VAG2530BL

Blue / Blu / Bleu

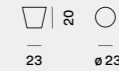

kg 4

VAG2023PR

Burgundy / Prugna / Prune

VAG2023GI

Yellow / Giallo / Jaune

VAG2023VO

Olive green / Verde oliva /
Olive vert

VAG2023BL

Blue / Blu / Bleu

Concrete vases / Vasi in cemento / Vases en béton

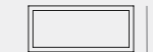

kg 31

VACE408035

Concrete / Cemento / Béton

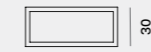

kg 17

VACE307030

Concrete / Cemento / Béton



Finishes / Finiture / Finitions

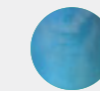

Glazed stoneware blue
Gres smaltato blu
Grès émaillé bleu

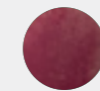

Glazed stoneware burgundy
Gres smaltato prugna
Grès émaillé prugna

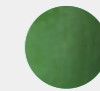

Glazed stoneware green
Gres smaltato verde
Grès émaillé vert

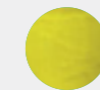

Glazed stoneware yellow
Gres smaltato giallo
Grès émaillé jaune



Concrete
Cemento
Béton

Care and
Maintenance

Cleaning kit & Paint

Protection Covers

Cleaning kit & Paint

Unopiù offers a kit consisting of a Cleaner detergent and a Protector product for cleaning and maintaining teak outdoor furniture. The former is a water-based detergent that can clean and restore teak to its original colour; the latter is an easy-to-apply protective that protects against moisture and helps to maintain the characteristic bright and luminous honey colour of the wood for longer.

IT Per la pulizia e manutenzione degli arredi da esterni in teak Unopiù offre un Kit composto da un detergente Cleaner e da un prodotto Protector. Il primo è un detergente a base d'acqua in grado di pulire e riportare il teak al suo colore originario; il secondo è un protettivo di semplice applicazione che protegge dall'incursione dell'umidità e aiuta a mantenere più a lungo il caratteristico color miele del legno, brillante e luminoso.

FR Pour le nettoyage et la maintenance des meubles d'extérieur en teck, Unopiù propose un Kit composé du détergent Cleaner et du produit Protector. Le premier est un détergent à base d'eau qui nettoie et restitue sa couleur originale au teck. Le second est un protecteur simple à appliquer qui protège contre l'humidité et permet de conserver durablement la couleur miel brillante et lumineuse qui caractérise ce bois.



Protection Covers

Summary

Finishes & Materials Colour Collection

LUCE			
Armchair cover green	Copertura verde per poltrona	Housse verte pour fauteuil	C7272
Sofa cover green	Copertura verde per divano	Housse verte pour canapé	C14471
Chair and small armchair cover green	Copertura verde per sedia e poltroncina	Housse verte pour chaise et petit fauteuil	C64
Stool cover green	Copertura verde per sgabello	Housse verte pour tabouret	C6258
Square table cover green 80x80 cm	Copertura verde per tavolo quadrato 80 x 80	Housse verte pour table carrée 80 x 80	C80
Sunlounger cover green	Copertura verde per lettino	Housse verte pour bain de soleil	C206
PEVERO			
Armchair cover green	Copertura per poltrona	Housse verte pour fauteuil	C95
Sofa cover green 150 cm	Copertura per divano cm 150	Housse verte pour canapé 150 cm	C153
Sofa cover green 200 cm	Copertura per divano cm 200	Housse verte pour canapé 200 cm	C211
Small armchair cover green PEVSETC	Copertura per poltroncina PEVSETC	Housse verte pour petit fauteuil PEVSETC	C60
Small armchair cover green COPOL OCPOLB OCPOLG	Copertura per poltroncine COPOL OCPOLB OCPOLG	Housse verte pour petit fauteuils COPOL OCPOLB OCPOLG	C69
Sunlounger cover green	Copertura per lettino	Housse verte pour bain de soleil	C206
Square table cover green	Copertura per tavolo quadrato	Housse verte pour table carré	C80
Rectangular table cover green	Copertura per tavolo rettangolare	Housse verte pour table rectangulaire	C160
SYNTHESIS			
Cover green for chair	Copertura verde per sedia	Housse verte pour chaise	C5453
Cover green for small armchair	Copertura verde per poltroncina	Housse verte pour petit fauteuil	C60
Cover green small armchair low	Copertura verde per poltroncina bassa	Housse verte pour petit fauteuil bas	C6069
Cover green for armchair SYPO	Copertura verde per poltrona SYPO	Housse verte pour fauteuil SYPO	C8093
Cover green for SDRASY/POLOS	Copertura verde per SDRASY/POLOS	Housse verte pour fauteuils SDRASY/POLOS	C6586
Cover green for sofa SYDI/SYLD	Copertura verde per divano SYDI/SYLD	Housse verte pour canapé SYDI/SYLD	C212
Cover green for pouf SYPU	Copertura verde per pouf SYPU	Housse verte pour canapé SYPU	C106
Cover green for sofa SYDIG	Copertura verde per divano SYDIG	Housse verte pour canapé SYDIG	C262
Cover green for modular sofa	Copertura verde per divani modulari	Housse verte pour canapés modulaires	C162
Cover green for sunlounger	Copertura verde per lettino	Housse verte pour bain de soleil	C206
Cover green for square table 150 x 150	Copertura verde per tavolo quadrato 150 x 150	Housse verte pour table carrée 150 x 150	C150D
Cover green for table 230 x 100	Copertura verde per tavolo 230 x 100	Housse verte pour table 230 x 100	C237
Cover green for table TASYQB	Copertura verde per tavolo TASYQB	Housse verte pour table TASYQB	C92
Cover green for table TAQULESY	Copertura verde per tavolo TAQULESY	Housse verte pour table TAQULESY	C9276
Cover green for coffee table SYTABQM	Copertura verde per tavolo basso SYTABQM	Housse verte pour table basse SYTABQM	C5755
Cover green for coffee table SYTABRM	Copertura verde per tavolo basso SYTABRM	Housse verte pour table basse SYTABRM	C12956
Cover green for coffee table SYTABR	Copertura verde per tavolo basso SYTABR	Housse verte pour table basse SYTABR	C15484
TOSCANA			
Armchair cover green	Copertura verde per poltrona	Housse verte pour fauteuil	C82
Sofa cover green	Copertura verde per divano	Housse verte pour canapé	C175

Sofas

Teak / Mahogany
Teak / Mogano
Teck / Acajou



CHELSEA
82 - 111



CHELSEA
82 - 111



PEVERO
176 - 197



SYNTHESIS
198 - 223



SYNTHESIS MODULAR
198 - 223



WELCOME
258 - 271



C'EST LA VIE
66 - 81

Synthetic fibre
Fibra sintetica
Fibre synthétique



AGORÀ MODULAR
18 - 37



AGORÀ LINEARE
18 - 37



EXPERIENCE
124 - 135



LUCE
154 - 167



OLIMPIA
168 - 175

Aluminum and iron
Alluminio e ferro
Aluminium et fer



LES ARCS
136 - 153



TLINE
232 - 245



ARIETE
38 - 49



AURORA
50 - 65



TOSCANA
246 - 257

Armchairs

Teak / Mahogany
Teak / Mogano
Teck / Acajou



CHELSEA
82 - 111



CHELSEA
82 - 111



CHELSEA
82 - 111



PEVERO
176 - 197



SYNTHESIS
198 - 223



SYNTHESIS
198 - 223



C'EST LA VIE
66 - 81

Synthetic fibre
Fibra sintetica
Fibre synthétique



AGORÀ
18 - 37



LUCE
154 - 167



OLIMPIA
168 - 175

Aluminum and iron
Alluminio e ferro
Aluminium et fer



LES ARCS
136 - 153



TLINE
232 - 245



ARIETE
38 - 49



AURORA
50 - 65



TOSCANA
246 - 257

Chairs and small armchairs

Teak
Teak
Teck



CHELSEA
82 - 111



CHELSEA
82 - 111



CHELSEA
82 - 111



PEVERO
176-197



PEVERO
176 - 197



SYNTHESIS
198 - 223

Synthetic fibre
Fibra sintetica
Fibre synthétique



AGORÀ
18 - 37



LUCE
154 - 167



EXPERIENCE
124 - 135



CAPRI
394 - 399

Aluminum and iron
Alluminio e ferro
Aluminium et fer



LES ARCS
136 - 153



TLINE
232 - 245



ARIETE
38 - 49



AURORA
50 - 65



CONRAD
112 - 123



TOSCANA
246 - 257

Tables

Teak / Mahogany
Teak / Mogano
Teck / Acajou



CHELSEA
82 - 111



PEVERO
176 - 197



SYNTHESIS
198 - 223



C'EST LA VIE
66 - 81pg-

Synthetic fibre
Fibra sintetica
Fibre synthétique



AGORÀ
18 - 37

Aluminum and iron
Alluminio e ferro
Aluminium et fer



LES ARCS
136 - 153



EXPERIENCE
124 - 135



TLINE
232 - 245



TLINE
232 - 245



ARIETE
38 - 49



AURORA
50 - 65



CONRAD
112 - 123



LUCE
154 - 167



TOSCANA
246 - 257



TOSCANA
246 - 257

Coffee tables

Teak / Mahogany
Teak / Mogano
Teck / Acajou



CHELSEA
82 - 111



PEVERO
176 - 197



SYNTHESIS
198 - 223



WELCOME
258 - 271



C'EST LA VIE
66 - 81

Synthetic fibre
Fibra sintetica
Fibre synthétique



AGORÀ
18 - 37



EXPERIENCE
124 - 135



OLIMPIA
168 - 175

Aluminum and iron
Alluminio e ferro
Aluminium et fer



LES ARCS
136 - 153



LUCE
154 - 167



TOSCANA
246 - 257

Sunloungers and Chaise longues

Teak / Mahogany
Teak / Mogano
Teck / Acajou



CHELSEA
82 - 111



CHELSEA
82 - 111



CHELSEA
82 - 111



SYNTHESIS
198 - 223



SYNTHESIS
198 - 223



SYNTHESIS
198 - 223



SWING
224 - 231



PEVERO
176 - 197



PEVERO
176 - 197



C'EST LA VIE
66 - 81



C'EST LA VIE
66 - 81

Synthetic fibre
Fibra sintetica
Fibre synthétique



AGORÀ
18 - 37



AGORÀ
18 - 37



EXPERIENCE
124 - 135

Aluminum and iron
Alluminio e ferro
Aluminium et fer



LUCE
154 - 167



TLINE
232 - 245



AURORA
50 - 65

Complements and lights



AMANDA
368 - 375



ART OF THE TABLE
376 - 381



ATON
382 - 387



AURORA
50 - 65



BARBY
388 - 391



CHELSEA
82 - 111



CARPETS
398 - 403



HOTTY
404 - 407



JOLLY CUSHIONS
408 - 411



SOLAR SHOWER
412 - 415



SOLARE
416 - 423



URBN BALCONY
424 - 433



VASES
434 - 437

Sunshades



COVERCAR
274 - 279



DAFNE
280 - 283



LIPARI
284 - 293



MANTA
294 - 299



NAGI
300 - 313



NAGI
300 - 313



ORANGERIE
314 - 321



ORANGERIE
314 - 321



SALENTO
322 - 329



SALENTO
322 - 329



SHIBUYA®
330 - 339



SHIBUYA®
330 - 339



SOLAIRE
340 - 355



SOLAIRE
340 - 355



SOLAIRE
340 - 355



TIBISCO
356 - 366

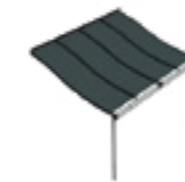

TIBISCO
356 - 366



TIBISCO
356 - 366

Finishes and Materials

Aesthetics and function guide the search for materials, chosen for their unparalleled resistance against all-weather agents, and available in natural and understated nuances, to furnish your outdoors in a stylish way.



IT Estetica e funzionalità guidano la ricerca dei materiali, scelti per la qualità impareggiabile di resistenza a tutti gli agenti atmosferici e proposti in finiture naturali e discrete, per arredare l'outdoor con stile.

L'esthétique et la fonctionnalité sont à la base de la recherche des matériaux, choisis pour leur qualité inégalée de résistance à tous les agents atmosphériques et proposés dans des finitions naturelles et discrètes, pour décorer l'extérieur avec style.

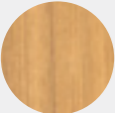
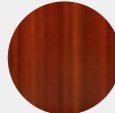
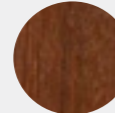
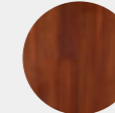
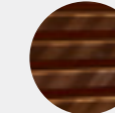
Wood / Legno / Bois

				
Teak Teak Teck	Polished mahogany Mogano lucido Acajou poli	Nordic pine Pino nordico Pin nordique	Iroko wood Legno di iroko Bois d'iroko	Wood - Skin Wood - Skin Wood - Skin

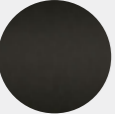
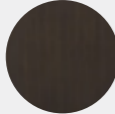
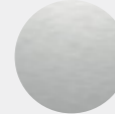
Galvanized iron and stainless steel / Ferro zincato e acciaio / Fer galvanisé et acier inoxydable

			
Graphite Grafite Graphite	Bronze Bronzo Bronze	Stainless steel Acciaio inox Acier inoxydable	White Bianco Blanc





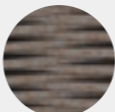
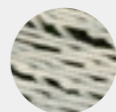
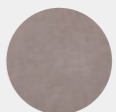

Aluminum / Alluminio / Aluminium

					
Graphite Grafite Graphite	Bronze Bronzo Bronze	White Bianco Blanc	Dove grey Tortora Gris tourterelle	Mud Fango Taupe	Avio Avio Avio
					
Olive green Verde oliva Olive vert	Red Rosso Rouge	Antique pink Rosa antico Rose antique			

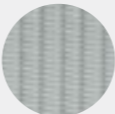
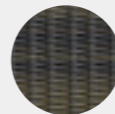
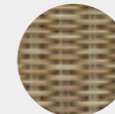
Synthetic cord / Corda sintetica / Corde synthétique

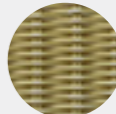
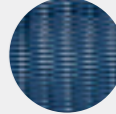
			
Polyolefin cord beige mélange Corda poliolefinica beige mélange Corde en polyoléfine beige mélange	Polyolefin cord anthracite Corda poliolefinica antracite Corde en polyoléfine anthracite	100% natural cotton off white Cotone 100% naturale bianco Coton blanc 100% naturel	Polypropylene grey mélange Polipropilene grigio mélange Polypropylène gris chiné

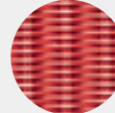
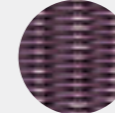

Synthetic fiber / Fibra sintetica / Fibre synthétique

					
WaProLace® white WaProLace® bianco WaProLace® blanc	WaProLace® antique brown WaProLace® antique brown WaProLace® antique brown	WaProLace® natural WaProLace® naturale WaProLace® naturel	WaProLace® sky blue WaProLace® azzurro WaProLace® bleu clair	WaProLace® yellow WaProLace® giallo WaProLace® jaune	WaProLace® blue WaProLace® blu WaProLace® bleu
					
WaProLace® green WaProLace® verde WaProLace® vert	WaProLace® red WaProLace® rosso WaProLace® rouge	WaProLace® burgundy WaProLace® prugna WaProLace® prune	WaProLace® natural WaProLace® naturale WaProLace® naturel		

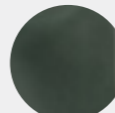
Leather / Pelle / Cuir

	
Orange Arancio Orange	Green Verde Vert

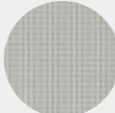
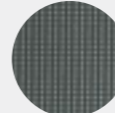
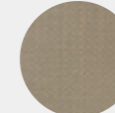
Technical fabrics / Tessuti tecnici / Tissus techniques

			
Polyester chenille Ciniglia di poliestere Chenille en polyester	Brown technical fabric Tessuto tecnico brown Tissu technique en brown	Canatex beige Canatex beige Canatex beige	Plastic fabric white Tessuto plastico trapuntato bianco Tissu plastique matelassé blanc

Masterline Colour Collection

The Masterline Colour Collection includes acrylic and waterproof fabric in soft hues, perfect all year long.

IT La Colour Collection Masterline comprende tessuti acrilici e waterproof dalle tonalità tenui e discrete, mirati a soddisfare la domanda dei prodotti in tutti i periodi dell'anno.

FR La Colour Collection Masterline comprend des tissus acryliques et imperméables dans des tons doux et discrets, visant à satisfaire la demande de produits à tout moment de l'année.

Outdoor acrylic

Polypropylene and Polyester / Polipropilene e poliestere / Polypropylène Polyester



Diamante 001



Latte 04



Nocciola 115

Waterproof

Polypropylene and Polyester / Polipropilene e poliestere / Polypropylène Polyester



Perla delicato 130



Perla intenso 120



Cammeo intenso 121



Cammeo delicato 131

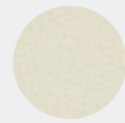

Onice bianco 147



Giada delicato 134



Granito 129



Ardesia delicato 138



Topazio 128



Turchese delicato 136

Made to order Colour Collection

Outdoor acrylic

Polypropylene and Polyester / Polipropilene e poliestere / Polypropylène Polyester



Quarzo fumé 002

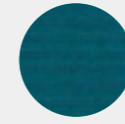

Smeraldo 98

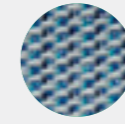

Acquamarina 003

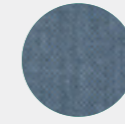

Ginepro 113

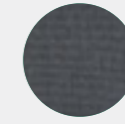

Pepe 114

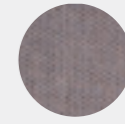

Seta 119



Caramello 126



Zucchero filato 127

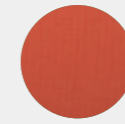

Paprika 140



Limone 141



Pistacchio 142

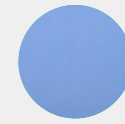

Mare 143

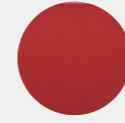

Peperoncino 144

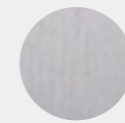

Lino 145

Waterproof

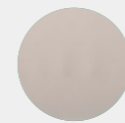

Quarzo 148

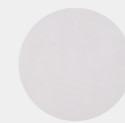

Pietra di luna 146

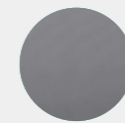

Agata grigia 150

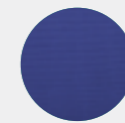

Quarzo blu 149

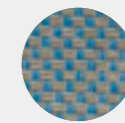

Turchese intenso 137



Ambra delicato 132

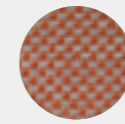

Ambra intenso 133

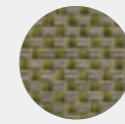

Giada intenso 135

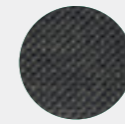

Ardesia intenso 139



Granata 152

Made to order Colour Collection

British standard

Fireproof polyester / Pollestere ignifugo / Polyester ignifuge



12i White



21i Cord



19i Dove Grey



13i Acid Green

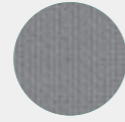

15i Grey

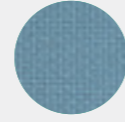

17i Sky Blue



18i Bright Blue

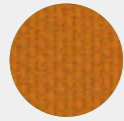

01i Orange

Velvet Fischbacher / Velluto Fischbacher / Velours Fischbacher

70% recycled PET / 70% PET riciclato / 70% PET recyclé



Margherita 1000



Elena 1002



Costanza 1003

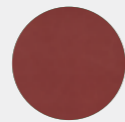

Bianca 1004

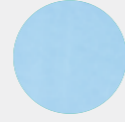

Maria Antonietta 1012

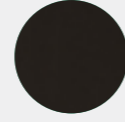

Carlotta 1013



Caterina 1010

Stores

ITALY

GENOVA
Via 12 Ottobre, 94/R
16121 Genova
Tel. +39 010 2759165

MILANO
Via Pontaccio, 9 - 20121 Milano
Tel. +39 02 72094197

TORINO
Corso Marche, 36 - 10146 Torino
Tel. +39 011 4240098

VITERBO
S. S. Ortana, km 14,500
01038 Soriano nel Cimino
Tel. +39 0761 7581

SPAIN

BARCELONA
Calle Riera Fonollar, 41/A
08830 Sant Boi de Llobregat
Tel. +34 93 652 97 97

MADRID
Calle Lagasca, 73
28001 Madrid
Tel. +34 91 659 26 20

FRANCE

BORDEAUX
55, Rue de Touleyre, RD 1113
33140 Cadaujac
Tél. +33 (0) 5 56 30 01 32

CANNES
Palace Center 1, Z.I. des Tourrades
06210 Mandelieu
Tél. +33 (0) 4 92 19 57 77

MARSEILLE
286, Avenue du Millet, Z.I. Les Paluds
13400 Aubagne
Tél. +33 (0) 4 42 18 60 80

PARIS
Coming soon

GERMANY

MÜNCHEN
Coming soon

Unopiù Spa

SEDE
T +39 0761 758 1
info@unopiu.it
www.unopiu.it

ENGLAND
www.unopiu.co.uk

FRANCE
www.unopiu.fr
info@unopiu.fr

SPAIN
www.unopiu.es
pedidos@unopiu.es

GERMANY
www.unopiu.de
info@unopiu.de

SWITZERLAND
www.unopiu.ch

AUSTRIA
www.unopiu.at

ORDINI PROGETTI PREVENTIVI
ufficiotecnico@unopiu.it
T +39 0761 758 888
lun-ven 10-13 / 15-19 / sab 10-19

CONTRACT
T +39 0761 758986
up.contract@unopiu.com

ASSISTENZA CLIENTI
T +39 0761 758 111
assistenza.clienti@unopiu.it
customer.service@unopiu.co.uk - ENG
kundenservice@unopiu.de - DE
service.apresvente@unopiu.fr - FR
postventa@unopiu.es - ES

ORDINI
ordini@unopiu.it
order@unopiu.co.uk - ENG
estero@unopiu.it - EU / WORLD

PROGETTI E PREVENTIVI

Il mondo delle strutture Unopiù è estremamente ricco e complesso e una conoscenza approfondita delle soluzioni tecniche e costruttive consente di esprimerlo al meglio.

Il catalogo può rappresentare solo in parte le infinite possibilità di costruzione e personalizzazione e l'ufficio tecnico Unopiù è pertanto a disposizione dei nostri clienti per suggerire la struttura più adatta ad ogni specifica situazione, personalizzarla con i giusti accessori, adattarla alle misure dell'ambiente in cui verrà inserita e fornire un preventivo dettagliato.

Avvertenza:

Il colore dei prodotti presentati nel Catalogo può risentire sia delle condizioni di luce in cui sono state effettuate le foto, sia della qualità di stampa. Unopiù si riserva il diritto di apportare modifiche o variazioni ai prodotti durante l'anno. È vietata la riproduzione totale o parziale di testi, foto e illustrazioni, salvo autorizzazione scritta della direzione di Unopiù S.p.A.

Creative direction
Lucia Cavalieri

Art direction
Leonardo Pertile

Photo

Mattia Greggi
Pierrick Verny
Adriano Brusaferrri
Mauro Mattioli
Fabrizio Bergamo
Gionata Xerra

ECOLIGHT

Unopiù, sensibile ed attenta alla salvaguardia dell'ambiente, rispetta i parametri della norma europea RoHS/RAEE.
Fa parte del consorzio ECOLIGHT che prevede la raccolta e lo smaltimento dei prodotti a fine vita secondo standard rigorosamente ecologici.

FACEBOOK
facebook.com/unopiu/

INSTAGRAM
instagram.com/unopiu.official/

E condividi le tue foto con l'hashtag
#unopiu



UNOPIÙ S.p.A. di Socio Unico
Sede Legale in Milano - 20121 Via Pontaccio, 9

Sede Operativa:

S. S. Ortana km 14,5 - 01038 Soriano nel Cimino (VT)
tel. 0761 7581 - fax 0761 758555 - info@unopiu.it
C.C.I.A.A. di Milano - R.E.A. MI 1876667
R. Imprese di Milano
Partita IVA e Codice Fiscale 05516670964

UNOPIU'
SINCE 1978